

# Titen HD® Heavy-Duty Screw Anchor

A high-strength screw anchor for use in cracked and uncracked concrete, as well as uncracked masonry. The Titen HD offers low installation torque and outstanding performance. Designed for use in dry, interior, non-corrosive environments or temporary outdoor applications.

## Features

- Tested in accordance with ACI 355.2, AC193 and AC106
- Qualified for static and seismic loading conditions
- Thread design undercuts to efficiently transfer the load to the base material
- Standard fractional sizes
- Specialized heat-treating process creates tip hardness for better cutting without compromising the ductility
- No special drill bit required — designed to install using standard-sized ANSI tolerance drill bits
- Hex-washer head requires no separate washer, unless required by code, and provides a clean installed appearance
- Removable — ideal for temporary anchoring (e.g. formwork, bracing) or applications where fixtures may need to be moved
- Reuse of the anchor will not achieve listed loads and is not recommended

**Codes:** ICC-ES ESR-2713 (concrete);

ICC-ES ESR-1056 (masonry);

City of LA Supplement within ESR-2713 (concrete);

City of LA Supplement within ESR-1056 (masonry);

Florida FL15730 (concrete and masonry);

FM 3017082, 3035761 and 3043442;

Multiple DOT listings

**Material:** Carbon steel

**Coating:** Zinc plated or mechanically galvanized.

Not recommended for permanent exterior use or highly corrosive environments.

## Installation

 Holes in steel fixtures to be mounted should match the diameter specified in the table below.

Use a Titen HD screw anchor one time only — installing the anchor multiple times may result in excessive thread wear and reduce load capacity.

 Do not use impact wrenches to install into hollow CMU.

 **Caution:** Oversized holes in base material will reduce or eliminate the mechanical interlock of the threads with the base material and reduce the anchor's load capacity.

1. Drill a hole in the base material using a carbide drill bit the same diameter as the nominal diameter of the anchor to be installed. Drill the hole to the specified embedment depth plus minimum hole depth overdrill (see table below) to allow the thread tapping dust to settle, and blow it clean using compressed air. (Overhead installations need not be blown clean.) Alternatively, drill the hole deep enough to accommodate embedment depth and the dust from drilling and tapping.
2. Insert the anchor through the fixture and into the hole.
3. Tighten the anchor into the base material until the hex-washer head contacts the fixture.

## Additional Installation Information

Titen HD® Diameter (in.)	Wrench Size (in.)	Recommended Steel Fixture Hole Size (in.)	Minimum Hole Depth Overdrill (in.)
1/4	3/8	3/8 to 7/16	1/8
3/8	9/16	1/2 to 9/16	1/4
1/2	3/4	5/8 to 11/16	1/2
5/8	15/16	3/4 to 13/16	1/2
3/4	1 1/8	7/8 to 15/16	1/2

Suggested fixture hole sizes are for structural steel thicker than 12 gauge only. Larger holes are not required for wood or thinner cold-formed steel members.



Serrated teeth on the tip of the Titen HD® screw anchor facilitate cutting and reduce installation torque.

**Titen HD  
Screw Anchor**

## Installation Sequence

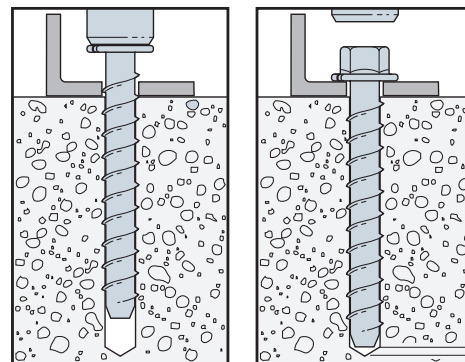
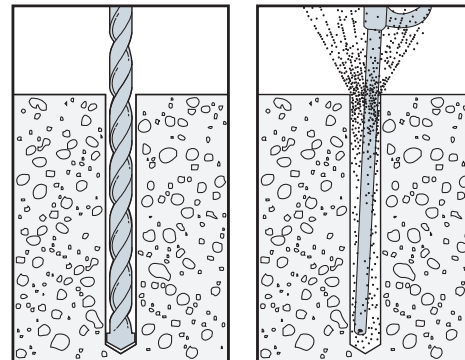

Minimum overdrill. See table.

# Titen HD® Heavy-Duty Screw Anchor

## Countersunk Head Style

The countersunk head style is for applications that require a flush-mount profile. Countersinking also leaves a cleaner surface appearance for exposed through-set applications. The anchor head's 6-lobe drive eases installation and is less prone to stripping than traditional recessed anchor heads.

### Features

- Available in many standard lengths in 1/4" and 3/8" diameters
- Driver bit included in each box

**Codes:** ICC-ES ESR-2713 (concrete);

ICC-ES ESR-1056 (masonry);

City of LA Supplement within ESR-2713 (concrete);

City of LA Supplement within ESR-1056 (masonry);

Florida FL15730 (concrete and masonry)

**Material:** Carbon steel

**Coating:** Zinc plated

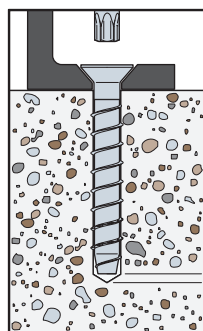

### Additional Installation Information

Titen HD Diameter (in.)	Bit Size	Recommended Steel Fixture Hole Size (in.)	Minimum Hole Depth Overdrill (in.)
1/4	T30	3/8 to 7/16	1/8
3/8	T50	1/2 to 9/16	1/4

Suggested fixture hole sizes are for structural steel thicker than 12 gauge only. Larger holes are not required for wood or thinner cold-formed steel members.

Minimum overdrill. See table.



6-lobe drive

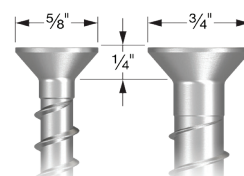

Titen HD Countersunk Head Style

1/4"

3/8"

Mechanical Anchors

## Washer-Head Head Style

The washer-head design is commonly used where a minimal head profile is necessary. The model is offered in sizes suitable for use in sill plate applications, and the washer head's low installed profile means modular wall and floor systems can be installed on top with no need for notching the wall framing to accommodate the anchor. The anchor's 6-lobe drive eases driving and is less prone to stripping.

### Features

- Available in many standard lengths in 1/2" and 5/8" diameters
- Driver bit included in each box

**Codes:** ICC-ES ESR-2713 (concrete);

City of LA Supplement within ESR-2713 (concrete)

Florida FL15730 (concrete)

**Material:** Carbon steel

**Coating:** Zinc plated

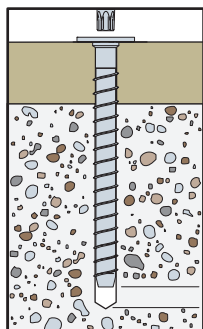

### Additional Installation Information

Titen HD Diameter (in.)	Bit Size	Recommended Steel Fixture Hole Size (in.)	Minimum Hole Depth Overdrill (in.)
1/2	T50	5/8 to 11/16	1/2
5/8	T60	3/4 to 13/16	1/2

Suggested fixture hole sizes are for structural steel thicker than 12 gauge only. Larger holes are not required for wood or thinner cold-formed steel members.

Minimum overdrill. See table.

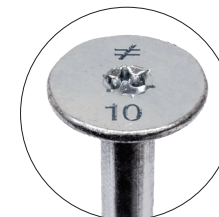

6-lobe drive

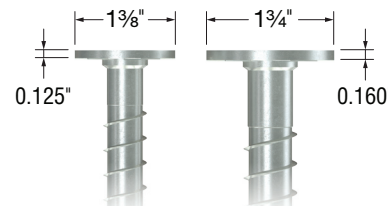

Titen HD Washer-Head Head Style

1/2"

5/8"

# Titen HD® Heavy-Duty Screw Anchor

## Titen HD Anchor Product Data — Zinc Plated









Size (in.)	Model No.	Thread Length (in.)	Drill Bit Diameter (in.)	Wrench Size (in.)	Quantity	
					Box	Carton
¼ x 1⅞	THDB25178H	1½	¼	⅜	100	500
¼ x 2¾	THDB25234H	2⅞	¼	⅜	50	250
¼ x 3	THDB25300H	2⅞	¼	⅜	50	250
¼ x 3½	THDB25312H	3⅞	¼	⅜	50	250
¼ x 4	THDB25400H	3⅞	¼	⅜	50	250
⅜ x 1¾	THD37134H†	1¼	⅜	⅞	50	250
⅜ x 2½	THD37212H†	2	⅜	⅞	50	200
⅜ x 3	THD37300H	2½	⅜	⅞	50	200
⅜ x 4	THD37400H	3½	⅜	⅞	50	200
⅜ x 5	THD37500H	4½	⅜	⅞	50	100
⅜ x 6	THD37600H	5½	⅜	⅞	50	100
½ x 3	THD50300H	2½	½	¾	25	100
½ x 4	THD50400H	3½	½	¾	20	80
½ x 5	THD50500H	4½	½	¾	20	80
½ x 6	THD50600H	5½	½	¾	20	80
½ x 6½	THD50612H	5½	½	¾	20	40
½ x 8	THD50800H	5½	½	¾	20	40
½ x 12	THD501200H	5½	½	¾	5	25
½ x 13	THD501300H	5½	½	¾	5	25
½ x 14	THD501400H	5½	½	¾	5	25
½ x 15	THD501500H	5½	½	¾	5	25
⅝ x 4	THDB62400H	3½	⅝	1⅝	10	40
⅝ x 5	THDB62500H	4½	⅝	1⅝	10	40
⅝ x 6	THDB62600H	5½	⅝	1⅝	10	40
⅝ x 6½	THDB62612H	5½	⅝	1⅝	10	40
⅝ x 8	THDB62800H	5½	⅝	1⅝	10	20
⅝ x 10	THDB62100H	5½	⅝	1⅝	10	20
¾ x 4	THD75400H	3½	¾	1⅞	10	40
¾ x 5	THD75500H	4½	¾	1⅞	5	20
¾ x 6	THDT75600H	4½	¾	1⅞	5	20
¾ x 7	THD75700H	5½	¾	1⅞	5	10
¾ x 8½	THD75812H	5½	¾	1⅞	5	10
¾ x 10	THD75100H	5½	¾	1⅞	5	10

† These models do not meet minimum embedment depth requirements for strength design and require maximum installation torque of 25 ft. – lb. using a torque wrench, driver drill or cordless ¼" impact driver with a maximum permitted torque rating of 100 ft. – lb.

1. Length of anchor is measured from underside of head to end of anchor.

## Titen HD® Heavy-Duty Screw Anchor





## Titen HD Anchor Product Data — Countersunk — Zinc Plated

Size (in.)	Model No.	Thread Length (in.)	Drill Bit Diameter (in.)	Wrench Size (in.)	Quantity	
					Box	Carton
 ¼ x 1 7/8	THDB25178CS	1 ½	¼	T30	100	500
 ¼ x 2 ¾	THDB25234CS	2 ¾	¼	T30	50	250
 ¼ x 3 ½	THDB25312CS	3 ¾	¼	T30	50	250
 ¼ x 4 ½	THDB25412CS	4 ¾	¼	T30	50	250
 ¾ x 2 ½	THD37212CS†	2	¾	T50	50	200
 ¾ x 3	THD37300CS	2 ½	¾	T50	50	200
 ¾ x 4	THD37400CS	3 ½	¾	T50	50	200
 ¾ x 5	THD37500CS	4 ½	¾	T50	50	100

† This model does not meet minimum embedment depth requirements for strength design and require maximum installation torque of 25 ft. – lb. using a torque wrench, driver drill or cordless ¼" impact driver with a maximum permitted torque rating of 100 ft. – lb.

1. Length of anchor is measured from top of head to bottom of anchor.

## Titen HD Anchor Product Data — Washer Head — Zinc Plated

Size (in.)	Model No.	Thread Length (in.)	Drill Bit Diameter (in.)	Bit Size	Quantity	
					Box	Carton
 ½ x 6	THD50600WH	5 ½	½	T50	15	60
 ½ x 8	THD50800WH	5 ½	½	T50	15	30
 ¾ x 6	THDB62600WH	5 ½	¾	T60	10	40
 ¾ x 8	THDB62800WH	5 ½	¾	T60	10	20
 ¾ x 10	THDB62100WH	5 ½	¾	T60	10	20

1. Length of anchor is measured from top of head to bottom of anchor.

# Titen HD® Heavy-Duty Screw Anchor

Mechanical Anchors

## Titen HD Anchor Product Data — Mechanically Galvanized

Size (in.)	Model No.	Thread Length (in.)	Drill Bit Diameter (in.)	Wrench Size (in.)	Quantity	
					Box	Carton
3/8 x 3	THD37300HMG	2 1/2	3/8	9/16	50	200
3/8 x 4	THD37400HMG	3 1/2			50	200
3/8 x 5	THD37500HMG	4 1/2			50	100
3/8 x 6	THD37600HMG	5 1/2			50	100
1/2 x 4	THD50400HMG	3 1/2	1/2	3/4	20	80
1/2 x 5	THD50500HMG	4 1/2			20	80
1/2 x 6	THD50600HMG	5 1/2			20	80
1/2 x 6 1/2	THD50612HMG	5 1/2			20	40
1/2 x 8	THD50800HMG	5 1/2			20	40
1/2 x 12	THD501200HMG	5 1/2			5	20
5/8 x 5	THDB62500HMG	4 1/2	5/8	1 5/16	10	40
5/8 x 6	THDB62600HMG	5 1/2			10	40
5/8 x 6 1/2	THDB62612HMG	5 1/2			10	40
5/8 x 8	THDB62800HMG	5 1/2			10	20
3/4 x 5	THD75500HMG	4 1/2	3/4	1 1/8	5	20
3/4 x 6	THDT75600HMG	4 1/2			5	20
3/4 x 8 1/2	THD75812HMG	5 1/2			5	10
3/4 x 10	THD75100HMG	5 1/2			5	10

Mechanical galvanizing meets ASTM B695, Class 65, Type 1. Intended for some pressure-treated wood sill plate applications. Not for use in other corrosive or outdoor environments. See p. 261 or visit [strongtie.com/info](http://strongtie.com/info) for more corrosion information.

## Titen HD Installation Information and Additional Data<sup>1</sup>



Characteristic	Symbol	Units	Nominal Anchor Diameter, d <sub>a</sub> (in.)											
			1/4		3/8		1/2		5/8		3/4			
<b>Installation Information</b>														
Drill Bit Diameter	<i>d<sub>bit</sub></i>	in.	1/4		3/8		1/2		5/8		3/4			
Baseplate Clearance Hole Diameter	<i>d<sub>c</sub></i>	in.	3/8		1/2		5/8		3/4		7/8			
Maximum Installation Torque	<i>T<sub>inst,max</sub></i>	ft.-lbf	24 <sup>2</sup>		50 <sup>2</sup>		65 <sup>2</sup>		100 <sup>2</sup>		150 <sup>2</sup>			
Maximum Impact Wrench Torque Rating	<i>T<sub>impact,max</sub></i>	ft.-lbf	125 <sup>3</sup>		150 <sup>3</sup>		340 <sup>3</sup>		340 <sup>3</sup>		385 <sup>3</sup>			
Minimum Hole Depth	<i>h<sub>hole</sub></i>	in.	1 3/4	2 5/8	2 3/4	3 1/2	3 3/4	4 1/2	4 1/2	6	4 1/2	6	6 3/4	
Nominal Embedment Depth	<i>h<sub>nom</sub></i>	in.	1 5/8	2 1/2	2 1/2	3 1/4	3 1/4	4	4	5 1/2	4	5 1/2	6 1/4	
Critical Edge Distance	<i>c<sub>ac</sub></i>	in.	3	6	2 1/16	3 5/8	3 9/16	4 1/2	4 1/2	6 3/8	6	6 3/8	7 5/16	
Minimum Edge Distance	<i>c<sub>min</sub></i>	in.	1 1/2				1 3/4							
Minimum Spacing	<i>s<sub>min</sub></i>	in.	1 1/2				3					2 3/4	3	
Minimum Concrete Thickness	<i>h<sub>min</sub></i>	in.	3 1/4	3 1/2	4	5	5	6 1/4	6	8 1/2	6	8 3/4	10	
<b>Additional Data</b>														
Anchor Category	Category	—	1											
Yield Strength	<i>f<sub>ya</sub></i>	psi	100,000				97,000							
Tensile Strength	<i>f<sub>uta</sub></i>	psi	125,000				110,000							
Minimum Tensile and Shear Stress Area	<i>A<sub>se</sub></i>	in <sup>2</sup>	0.042		0.099		0.183		0.276		0.414			
Axial Stiffness in Service Load Range — Uncracked Concrete	<i>β<sub>un-cr</sub></i>	lb./in.	202,000				672,000							
Axial Stiffness in Service Load Range — Cracked Concrete	<i>β<sub>cr</sub></i>	lb./in.	173,000				345,000							

- The information presented in this table is to be used in conjunction with the design criteria of ACI 318-14 Chapter 17 and ACI 318-11 Appendix D.
- T<sub>inst,max</sub>* is the maximum permitted installation torque for the embedment depth range covered by this table using a torque wrench.
- T<sub>impact,max</sub>* is the maximum permitted torque rating for impact wrenches for the embedment depth range covered by this table.

\* See p. 12 for an explanation of the load table icons.

# Titen HD® Design Information — Concrete



## Titen HD Tension Strength Design Data<sup>1</sup>

Characteristic	Symbol	Units	Nominal Anchor Diameter, d <sub>a</sub> (in.)											
			¼		⅜		½		⅝		¾			
Nominal Embedment Depth	<i>h<sub>nom</sub></i>	in.	1½	2½	2½	3¼	3¼	4	4	5½	4	5½	6¼	
<b>Steel Strength in Tension — ACI 318-14 Section 17.4.1 or ACI 318-11 Section D.5.1</b>														
Tension Resistance of Steel	<i>N<sub>sa</sub></i>	lb.	5,195		10,890		20,130		30,360		45,540			
Strength Reduction Factor — Steel Failure	<i>φ<sub>sa</sub></i>	—	0.65 <sup>2</sup>											
<b>Concrete Breakout Strength in Tension<sup>6</sup> — ACI 318-14 Section 17.4.2 or ACI 318-11 Section D.5.2</b>														
Effective Embedment Depth	<i>h<sub>ef</sub></i>	in.	1.19	1.94	1.77	2.40	2.35	2.99	2.97	4.24	2.94	4.22	4.86	
Critical Edge Distance <sup>6</sup>	<i>c<sub>ac</sub></i>	in.	3	6	2 <sup>11</sup> / <sub>16</sub>	3⅝	3 <sup>9</sup> / <sub>16</sub>	4½	4½	6⅝	6	6⅝	7 <sup>5</sup> / <sub>16</sub>	
Effectiveness Factor — Uncracked Concrete	<i>k<sub>uncr</sub></i>	—	30		24						27		24	
Effectiveness Factor — Cracked Concrete	<i>k<sub>cr</sub></i>	—	17											
Modification Factor	<i>ψ<sub>c,N</sub></i>	—	1.0											
Strength Reduction Factor — Concrete Breakout Failure	<i>φ<sub>cb</sub></i>	—	0.65 <sup>7</sup>											
<b>Pullout Strength in Tension — ACI 318-14 Section 17.4.3 or ACI 318-11 Section D.5.3</b>														
Pullout Resistance, Uncracked Concrete (f' <sub>c</sub> = 2,500 psi)	<i>N<sub>p,uncr</sub></i>	lb.	— <sup>3</sup>	— <sup>3</sup>	2,700 <sup>4</sup>	— <sup>3</sup>	— <sup>3</sup>	— <sup>3</sup>	— <sup>3</sup>	9,810 <sup>4</sup>	— <sup>3</sup>	— <sup>3</sup>	— <sup>3</sup>	
Pullout Resistance, Cracked Concrete (f' <sub>c</sub> = 2,500 psi)	<i>N<sub>p,cr</sub></i>	lb.	— <sup>3</sup>	1,905 <sup>4</sup>	1,235 <sup>4</sup>	2,700 <sup>4</sup>	— <sup>3</sup>	— <sup>3</sup>	3,040 <sup>4</sup>	5,570 <sup>4</sup>	— <sup>3</sup>	6,070 <sup>4</sup>	7,195 <sup>4</sup>	
Strength Reduction Factor — Concrete Pullout Failure	<i>φ<sub>p</sub></i>	—	0.65 <sup>5</sup>											
<b>Tension Strength for Seismic Applications — ACI 318-14 Section 17.4.2.3.3 or ACI 318-11 Section D.3.3.3</b>														
Nominal Pullout Strength for Seismic Loads (f' <sub>c</sub> = 2,500 psi)	<i>N<sub>p,eq</sub></i>	lb.	— <sup>3</sup>	1,905 <sup>4</sup>	1,235 <sup>4</sup>	2,700 <sup>4</sup>	— <sup>3</sup>	— <sup>3</sup>	3,040 <sup>4</sup>	5,570 <sup>4</sup>	3,840 <sup>4</sup>	6,070 <sup>4</sup>	7,195 <sup>4</sup>	
Strength Reduction Factor — Breakout or Pullout Failure	<i>φ<sub>eq</sub></i>	—	0.65 <sup>5</sup>											

- The information presented in this table is to be used in conjunction with the design criteria of ACI 318-14 Chapter 17 and ACI 318-11 Appendix D, except as modified below.
- The tabulated value of *φ<sub>sa</sub>* applies when the load combinations of Section 1605.2.1 of the IBC, ACI 318-14 Section 5.3 or ACI 318-11 Section 9.2 are used. If the load combinations of ACI 318-11 Appendix C are used, the appropriate value of *φ<sub>sa</sub>* must be determined in accordance with ACI 318-11 D.4.4. Anchors are considered brittle steel elements.
- Pullout strength is not reported since concrete breakout controls.
- Adjust the characteristic pullout resistance for other concrete compressive strengths by multiplying the tabular value by (f'<sub>c,specified</sub> / 2,500)<sup>0.5</sup>.
- The tabulated value of *φ<sub>p</sub>* or *φ<sub>eq</sub>* applies when the load combinations of Section 1605.2.1 of the IBC, ACI 318-14 Section 5.3 or ACI 318-11 Section 9.2 are used and the requirements of ACI 318-14 17.3.3(c) or ACI 318-11 D.4.3(c) for Condition B are met. If the load combinations of ACI 318-11 Appendix C are used, appropriate value of *φ* must be determined in accordance with ACI 318-11 Section D.4.4(c).
- The modification factor *ψ<sub>cp,N</sub>* = 1.0 for cracked concrete. Otherwise, the modification factor for uncracked concrete without supplementary reinforcement to control splitting is either:  
 (1) *ψ<sub>cp,N</sub>* = 1.0 if *c<sub>a,min</sub>* ≥ *c<sub>ac</sub>* or (2) *ψ<sub>cp,N</sub>* =  $\frac{c_{a,min}}{c_{ac}} \geq \frac{1.5h_{ef}}{c_{ac}}$  if *c<sub>a,min</sub>* < *c<sub>ac</sub>*  
 The modification factor, *ψ<sub>cp,N</sub>* is applied to the nominal concrete breakout strength, *N<sub>cb</sub>* or *N<sub>cbg</sub>*.
- The tabulated value of *φ<sub>cb</sub>* applies when both the load combinations of Section 1605.2.1 of the IBC, ACI 318-14 Section 5.3 or ACI 318-11 Section 9.2 are used and the requirements of ACI 318-14 17.3.3(c) or ACI 318-11 D.4.3(c) for Condition B are met. Condition B applies where supplementary reinforcement is not provided. For installations where complying supplementary reinforcement can be verified, the *φ<sub>cb</sub>* factors described in ACI 318-14 17.3.3(c) or ACI 318-11 D.4.3(c) for Condition A are allowed. If the load combinations of ACI 318-11 Appendix C are used, the appropriate value of *φ<sub>cb</sub>* must be determined in accordance with ACI 318-11 D.4.4(c).

C-A-2021 © 2021 SIMPSON STRONG-TIE COMPANY INC.

Mechanical Anchors

\* See p. 12 for an explanation of the load table icons.

# Titen HD® Design Information — Concrete

## Titen HD Shear Strength Design Data<sup>1</sup>

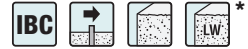

Characteristic	Symbol	Unit	Nominal Anchor Diameter, d <sub>a</sub> (in.)											
			1/4		3/8		1/2		5/8		3/4			
Nominal Embedment Depth	<i>h<sub>nom</sub></i>	in.	1 5/8	2 1/2	2 1/2	3 1/4	3 1/4	4	4	5 1/2	4	5 1/2	6 1/4	
<b>Steel Strength in Shear</b>														
Shear Resistance of Steel	<i>V<sub>sa</sub></i>	lb.	2,020		4,460		7,455		10,000		14,950		16,840	
Strength Reduction Factor — Steel Failure	$\phi_{sa}$	—	0.60 <sup>2</sup>											
<b>Concrete Breakout Strength in Shear</b>														
Outside Diameter	<i>d<sub>a</sub></i>	in.	0.25		0.375		0.500		0.625		0.750			
Load Bearing Length of Anchor in Shear	<i>ℓ<sub>e</sub></i>	in.	1.19	1.94	1.77	2.40	2.35	2.99	2.97	4.24	2.94	4.22	4.86	
Strength Reduction Factor — Concrete Breakout Failure	$\phi_{cb}$	—	0.70 <sup>3</sup>											
<b>Concrete Pryout Strength in Shear</b>														
Coefficient for Pryout Strength	<i>k<sub>cp</sub></i>	lb.	1.0						2.0					
Strength Reduction Factor — Concrete Pryout Failure	$\phi_{cp}$	—	0.70 <sup>4</sup>											
<b>Steel Strength in Shear for Seismic Applications</b>														
Shear Resistance for Seismic Loads	<i>V<sub>eq</sub></i>	lb.	1,695		2,855		4,790		8,000		9,350			
Strength Reduction Factor — Steel Failure	$\phi_{eq}$	—	0.60 <sup>2</sup>											

- The information presented in this table is to be used in conjunction with the design criteria of ACI 318-14 Chapter 17 and ACI 318-11 Appendix D, except as modified below.
- The tabulated value of  $\phi_{sa}$  and  $\phi_{eq}$  applies when the load combinations of Section 1605.2.1 of the IBC, ACI 318-14 Section 5.3 or ACI 318-11 Section 9.2 are used. If the load combinations of ACI 318-11 Appendix C are used, the appropriate value of  $\phi_{sa}$  and  $\phi_{eq}$  must be determined in accordance with ACI 318 D.4.4.
- The tabulated value of  $\phi_{cb}$  applies when both the load combinations of Section 1605.2.1 of the IBC, ACI 318-14 Section 5.3 or ACI 318-11 Section 9.2 are used and the requirements of ACI 318-14 17.3.3(c) or ACI 318-11 D.4.3(c) for Condition B are met. Condition B applies where supplementary reinforcement is not provided. For installations where complying supplementary reinforcement can be verified, the  $\phi_{cb}$  factors described in ACI 318-14 17.3.3(c) or ACI 318-11 D.4.3(c) for Condition A are allowed. If the load combinations of ACI 318-11 Appendix C are used, the appropriate value of  $\phi_{cb}$  must be determined in accordance with ACI 318-11 D.4.4(c).
- The tabulated value of  $\phi_{cp}$  applies when both the load combinations of IBC Section 1605.2, ACI 318-14 5.3 or ACI 318-11 Section 9.2 are used and the requirements of ACI 318-14 17.3.3(c) or ACI 318-11 D.4.3(c) for Condition B are met. If the load combinations of ACI 318-11 Appendix C are used, appropriate value of  $\phi_{cp}$  must be determined in accordance with ACI 318-11 Section D.4.4(c).

## Titen HD Tension and Shear Strength Design Data for the Soffit of Normal-Weight or Sand-Lightweight Concrete over Steel Deck<sup>1,6,7</sup>



Characteristic	Symbol	Units	Nominal Anchor Diameter, d <sub>a</sub> (in.)									
			Lower Flute						Upper Flute			
			Figure 2		Figure 1				Figure 2		Figure 1	
			1/4	3/8	1/2	3/4	1	1 1/4	1/4	3/8	1/2	3/4
Nominal Embedment Depth	<i>h<sub>nom</sub></i>	in.	1 5/8	2 1/2	1 7/8	2 1/2	2	3 1/2	1 5/8	2 1/2	1 7/8	2
Effective Embedment Depth	<i>h<sub>ef</sub></i>	in.	1.19	1.94	1.23	1.77	1.29	2.56	1.19	1.94	1.23	1.29
Pullout Resistance, concrete on steel deck (cracked) <sup>2,3,4</sup>	<i>N<sub>p,deck,cr</sub></i>	lb.	420	535	375	870	905	2,040	655	1,195	500	1,700
Pullout Resistance, concrete on steel deck (uncracked) <sup>2,3,4</sup>	<i>N<sub>p,deck,uncr</sub></i>	lb.	995	1,275	825	1,905	1,295	2,910	1,555	2,850	1,095	2,430
Steel Strength in Shear, concrete on steel deck <sup>5</sup>	<i>V<sub>sa,deck</sub></i>	lb.	1,335	1,745	2,240	2,395	2,435	4,430	2,010	2,420	4,180	7,145
Steel Strength in Shear, Seismic	<i>V<sub>sa,deck,eq</sub></i>	lb.	870	1,135	1,434	1,533	1,565	2,846	1,305	1,575	2,676	4,591

- The information presented in this table is to be used in conjunction with the design criteria of ACI 318-14 Chapter 17 and ACI 318-11 Appendix D, except as modified below.
- Concrete compressive strength shall be 3,000 psi minimum. The characteristic pullout resistance for greater compressive strengths shall be increased by multiplying the tabular value by  $(f'_{c,specified} / 3,000)^{0.5}$ .
- For anchors installed in the soffit of sand-lightweight or normal-weight concrete over steel deck floor and roof assemblies, as shown in Figure 1 and Figure 2, calculation of the concrete breakout strength may be omitted.
- In accordance with ACI 318-14 Section 17.4.3.2 or ACI 318-11 Section D.5.3.2, the nominal pullout strength in cracked concrete for anchors installed in the soffit of sand-lightweight or normal-weight concrete over steel deck floor and roof assemblies *N<sub>p,deck,cr</sub>* shall be substituted for *N<sub>p,cr</sub>*. Where analysis indicates no cracking at service loads, the normal pullout strength in uncracked concrete *N<sub>p,deck,uncr</sub>* shall be substituted for *N<sub>p,uncr</sub>*.
- In accordance with ACI 318-14 Section 17.5.1.2(C) or ACI 318-11 Section D.6.1.2(C), the shear strength for anchors installed in the soffit of sand-lightweight or normal-weight concrete over steel deck floor and roof assemblies *V<sub>sa,deck</sub>* and *V<sub>sa,deck,eq</sub>* shall be substituted for *V<sub>sa</sub>*.
- Minimum edge distance to edge of panel is  $2h_{ef}$ .
- The minimum anchor spacing along the flute must be the greater of  $3h_{ef}$  or 1.5 times the flute width.

\* See p. 12 for an explanation of the load table icons.

# Titen HD® Design Information — Concrete

Titen HD Anchor Tension and Shear Strength Design Data in the Topside of Normal-Weight Concrete or Sand-Lightweight Concrete over Steel Deck

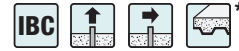

Design Information	Symbol	Units	Nominal Anchor Diameter, $d_a$ (in.)	
			Figure 3	Figure 3
			$\frac{1}{4}$	$\frac{3}{8}$
Nominal Embedment Depth	$h_{nom}$	in.	1½	2½
Effective Embedment Depth	$h_{ef}$	in.	1.19	1.77
Minimum Concrete Thickness	$h_{min,deck}$	in.	2½	3¼
Critical Edge Distance	$c_{ac,deck,top}$	in.	3¾	7¼
Minimum Edge Distance	$c_{min,deck,top}$	in.	3½	3
Minimum Spacing	$s_{min,deck,top}$	in.	3½	3

- For anchors installed in the topside of concrete-filled deck assemblies, as shown in Figures 2 and 3, the nominal concrete breakout strength of a single anchor or group of anchors in shear,  $V_{cb}$  or  $V_{cbg}$ , respectively, must be calculated in accordance with ACI 318-14 Section 17.5.2 or ACI 318-11 Section D.6.2, using the actual member thickness,  $h_{min,deck}$ , in the determination of  $A_{vc}$ .
- Design capacity shall be based on calculations according to values in the tables featured on p. 84.
- Minimum flute depth (distance from top of flute to bottom of flute) is 1½" (see Figures 2 and 3).
- Steel deck thickness shall be minimum 20 gauge.
- Minimum concrete thickness ( $h_{min,deck}$ ) refers to concrete thickness above upper flute (see Figures 2 and 3).

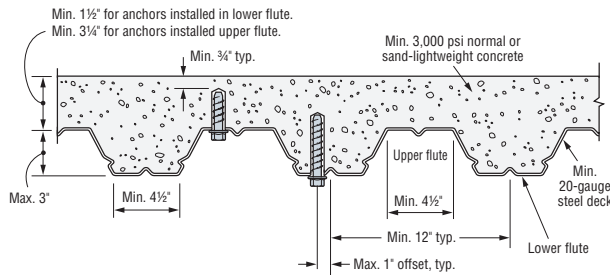

**Figure 1.** Installation of  $\frac{3}{8}$ "- and  $\frac{1}{2}$ "-Diameter Anchors in the Soffit of Concrete over Steel Deck

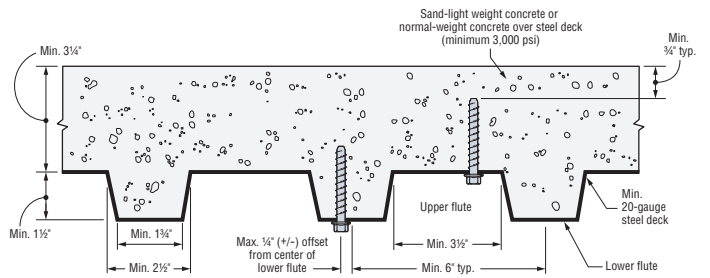

**Figure 2.** Installation of  $\frac{1}{4}$ "-Diameter Anchors in the Soffit of Concrete over Steel Deck

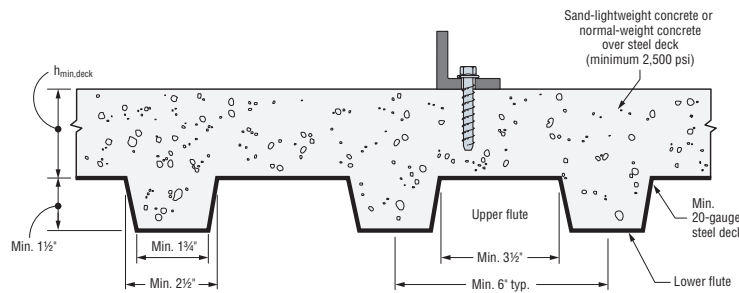

**Figure 3.** Installation of  $\frac{1}{4}$ "- and  $\frac{3}{8}$ "-Diameter Anchors in the Topside of Concrete over Steel Deck

C-A-2021 © 2021 SIMPSON STRONG-TIE COMPANY INC.

\* See p. 12 for an explanation of the load table icons.



# Titen HD® Design Information — Masonry

Titen HD Allowable Tension and Shear Loads in  
8" Lightweight, Medium-Weight and Normal-Weight Grout-Filled CMU

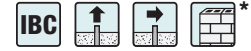

Mechanical Anchors

Size in. (mm)	Drill Bit Diameter in.	Minimum Embedment Depth in. (mm)	Critical Edge Distance $C_{crit}$ in. (mm)	Minimum Edge Distance $C_{min}$ in. (mm)	Critical Spacing Distance in. (mm)	Values for 8" Lightweight, Medium-Weight or Normal-Weight Grout-Filled CMU			
						Tension Load		Shear Load	
						Ultimate lb. (kN)	Allowable lb. (kN)	Ultimate lb. (kN)	Allowable lb. (kN)
<b>Anchor Installed in the Face of the CMU Wall (See Figure 4)</b>									
1/4 (6.4)	1/4	2 1/2 (64)	4 (102)	1 1/4 (32)	4 (102)	2,050 (9.1)	410 (1.8)	2,500 (11.1)	500 (2.2)
3/8 (9.5)	3/8	2 3/4 (70)	12 (305)	4 (102)	6 (152)	2,390 (10.6)	480 (2.1)	4,340 (19.3)	870 (3.9)
1/2 (12.7)	1/2	3 1/2 (89)	12 (305)	4 (102)	8 (203)	3,440 (15.3)	690 (3.1)	6,920 (30.8)	1,385 (6.2)
5/8 (15.9)	5/8	4 1/2 (114)	12 (305)	4 (102)	10 (254)	5,300 (23.6)	1,060 (4.7)	10,420 (46.4)	2,085 (9.3)
3/4 (19.1)	3/4	5 1/2 (140)	12 (305)	4 (102)	12 (305)	7,990 (35.5)	1,600 (7.1)	15,000 (66.7)	3,000 (13.3)

1. The tabulated allowable loads are based on a safety factor of 5.0 for installations under the IBC and IRC.
2. Values for 8"-wide, lightweight, medium-weight and normal-weight concrete masonry units.
3. The masonry units must be fully grouted.
4. The minimum specified compressive strength of masonry,  $f_m$ , at 28 days is 1,500 psi.
5. Embedment depth is measured from the outside face of the concrete masonry unit.
6. Grout-filled CMU wall design must satisfy applicable design standards and be capable of withstanding applied loads.
7. Refer to allowable load-adjustment factors for spacing and edge distance on pp. 90–91.

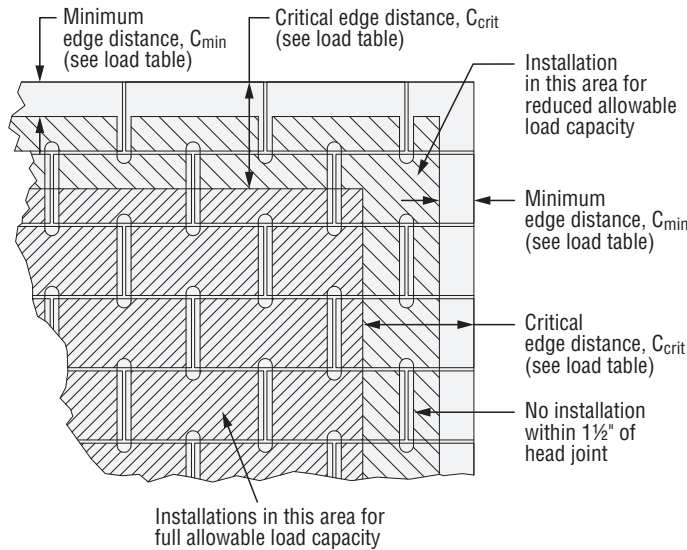

**Figure 4.** Shaded Area = Placement for Full and Reduced Allowable Load Capacity in Grout-Filled CMU

# Titen HD® Design Information — Masonry

Titen HD Allowable Tension and Shear Loads in  
8" Lightweight, Medium-Weight and Normal-Weight Hollow CMU



Size in. (mm)	Drill Bit Diameter in.	Embedment Depth <sup>4</sup> in. (mm)	Minimum Edge Distance in. (mm)	8" Hollow CMU Loads Based on CMU Strength			
				Tension Load		Shear Load	
				Ultimate lb. (kN)	Allowable lb. (kN)	Ultimate lb. (kN)	Allowable lb. (kN)
<b>Anchor Installed in Face Shell (See Figure 5)</b>							
3/8 (9.5)	3/8	1 3/4 (45)	4 (102)	720 (3.2)	145 (0.6)	1,240 (5.5)	250 (1.1)
1/2 (12.7)	1/2	1 3/4 (45)	4 (102)	760 (3.4)	150 (0.7)	1,240 (5.5)	250 (1.1)
5/8 (15.9)	5/8	1 3/4 (45)	4 (102)	800 (3.6)	160 (0.7)	1,240 (5.5)	250 (1.1)
3/4 (19.1)	3/4	1 3/4 (45)	4 (102)	880 (3.9)	175 (0.8)	1,240 (5.5)	250 (1.1)

- The tabulated allowable loads are based on a safety factor of 5.0 for installations under the IBC and IRC.  
**Note:** No installation within 4 5/8" of bed joint of hollow masonry block wall.
- Values for 8"-wide, lightweight, medium-weight and normal-weight concrete masonry units.
- The minimum specified compressive strength of masonry,  $f_m$ , at 28 days is 1,500 psi.
- Embedment depth is measured from the outside face of the concrete masonry unit and is based on the anchor being embedded an additional 1/2"- through 1 1/4"-thick face shell.
- Allowable loads may not be increased for short-term loading due to wind or seismic forces.  
CMU wall design must satisfy applicable design standards and be capable of withstanding applied loads.
- Do not use impact wrenches to install in hollow CMU.
- Set drill to rotation-only mode when drilling into hollow CMU.
- The tabulated allowable loads are based on one anchor installed in a single cell.
- Distance from centerline of anchor to head joint shall be a minimum of 4 5/8".

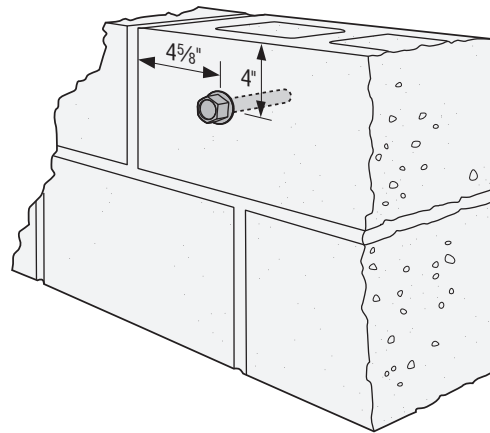
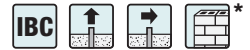

Figure 5

\* See p. 12 for an explanation of the load table icons.

# Titen HD® Design Information — Masonry

## Titen HD® Allowable Tension and Shear Loads in 8" Lightweight, Medium-Weight and Normal-Weight Grout-Filled CMU Stemwall



Size in. (mm)	Drill Bit Diameter in.	Embed. Depth in. (mm)	Minimum Edge Distance in. (mm)	Minimum End Distance in. (mm)	Critical Spacing Distance in. (mm)	8" Grout-Filled CMU Allowable Loads Based on CMU Strength, $f_m = 1,500$ psi					
						Tension		Shear Perpendicular to Edge		Shear Parallel to Edge	
						Ultimate lb. (kN)	Allowable lb. (kN)	Ultimate lb. (kN)	Allowable lb. (kN)	Ultimate lb. (kN)	Allowable lb. (kN)
<b>Anchor Installed in Cell Opening or Web (Top of Wall) (See Figure 6)</b>											
1/2 (12.7)	1/2	4 1/2 (114)	1 3/4 (45)	8 (203)	8 (203)	2,860 (12.7)	570 (2.5)	800 (3.6)	160 (0.7)	2,920 (13.0)	585 (2.6)
5/8 (15.9)	5/8	4 1/2 (114)	1 3/4 (45)	10 (254)	10 (254)	2,860 (12.7)	570 (2.5)	800 (3.6)	160 (0.7)	3,380 (15.0)	675 (3.0)

1. The tabulated allowable loads are based on a safety factor of 5.0 for installations under the IBC and IRC.
2. Values are for 8"-wide, lightweight, medium-weight and normal-weight concrete masonry units.
3. The masonry units must be fully grouted.
4. The minimum specified compressive strength of masonry,  $f_m$ , at 28 days is 1,500 psi.
5. Grout-filled CMU wall design must satisfy applicable design standards and be capable of withstanding applied design loads.
6. Loads are based on anchor installed in either the web or grout-filled cell opening in the top of wall.

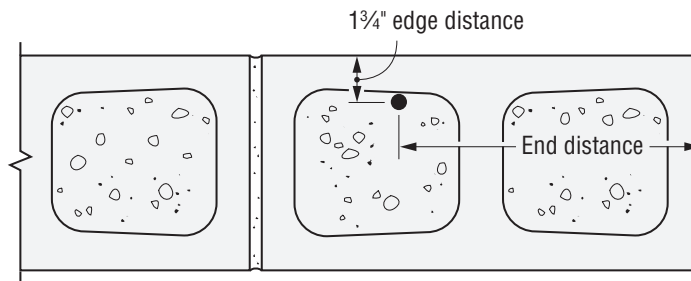

**Figure 6.**  
Anchor Installed in Top of Wall at 1 3/4" Edge Distance

## Titen HD® Allowable Tension and Shear Loads in 8" Medium-Weight and Normal-Weight Grout-Filled CMU Stemwall



Size in. (mm)	Drill Bit Diameter in.	Embed. Depth in. (mm)	Minimum Edge Distance in. (mm)	Minimum End Distance in. (mm)	Critical Spacing Distance in. (mm)	8" Grout-Filled CMU Allowable Loads Based on CMU Strength, $f_m = 2,000$ psi					
						Tension		Shear Perpendicular to Edge		Shear Parallel to Edge	
						Ultimate lb. (kN)	Allowable lb. (kN)	Ultimate lb. (kN)	Allowable lb. (kN)	Ultimate lb. (kN)	Allowable lb. (kN)
<b>Anchor Installed in Cell Opening (Top of Wall) (See Figure 7)</b>											
1/2 (12.7)	1/2	4 1/2 (114)	3 (76)	12 (305)	12 (305)	5,800 (25.8)	1,160 (5.2)	2,750 (12.2)	550 (2.5)	7,500 (33.4)	1,500 (6.7)
5/8 (15.9)	5/8										

1. The tabulated allowable loads are based on a safety factor of 5.0 for installations under the IBC and IRC.
2. Values are for 8"-wide, medium-weight and normal-weight concrete masonry units.
3. The masonry units must be fully grouted.
4. The minimum specified compressive strength of masonry,  $f_m$ , at 28 days is 2,000 psi.
5. Allowable loads are not permitted to be increased for short-term loading due to wind or seismic forces.
6. Grout-filled CMU wall design must satisfy applicable design standards and be capable of withstanding applied design loads.
7. Loads are based on anchor installed in grout-filled cell opening in the top of wall.

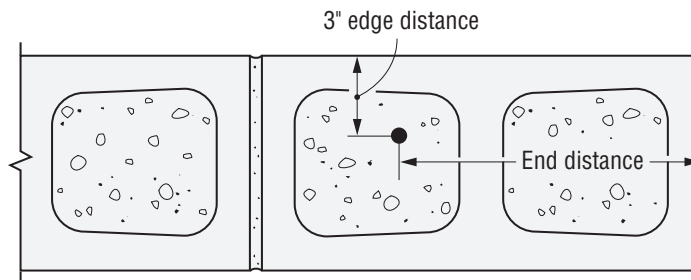

**Figure 7.**  
Anchor Installed in Top of Wall at 3" Edge Distance

# Titen HD® Design Information — Masonry

Titen HD Allowable Tension Loads for 8" Lightweight, Medium-Weight and Normal-Weight CMU Chair Blocks Filled with Normal-Weight Concrete



Size in. (mm)	Drill Bit Diameter (in.)	Minimum Embedment Depth in. (mm)	Minimum Edge Distance in. (mm)	Critical Spacing in. (mm)	8" Concrete-Filled CMU Chair Block Allowable Tension Loads Based on CMU Strength	
					Ultimate lb. (kN)	Allowable lb. (kN)
3/8 (9.5)	3/8	2 3/8 (60)	1 3/4 (44)	9 1/2 (241)	3,175 (14.1)	635 (2.8)
		3 3/8 (86)	1 3/4 (44)	13 1/2 (343)	5,175 (23.0)	1,035 (4.6)
		5 (127)	2 1/4 (57)	20 (508)	10,584 (47.1)	2,115 (9.4)
1/2 (12.7)	1/2	8 (203)	2 1/4 (57)	32 (813)	13,722 (61.0)	2,754 (12.2)
		10 (254)	2 1/4 (57)	40 (1016)	16,630 (74.0)	3,325 (14.8)
5/8 (15.9)	5/8	5 1/2 (140)	1 3/4 (44)	22 (559)	9,025 (40.1)	1,805 (8.1)

1. The tabulated allowable loads are based on a safety factor of 5.0.
2. Values are for 8"-wide concrete masonry units (CMU) filled with concrete, with minimum compressive strength of 2,500 psi and poured monolithically with the floor slab.
3. Center #5 rebar in CMU cell and concrete slab as shown in the illustration below.

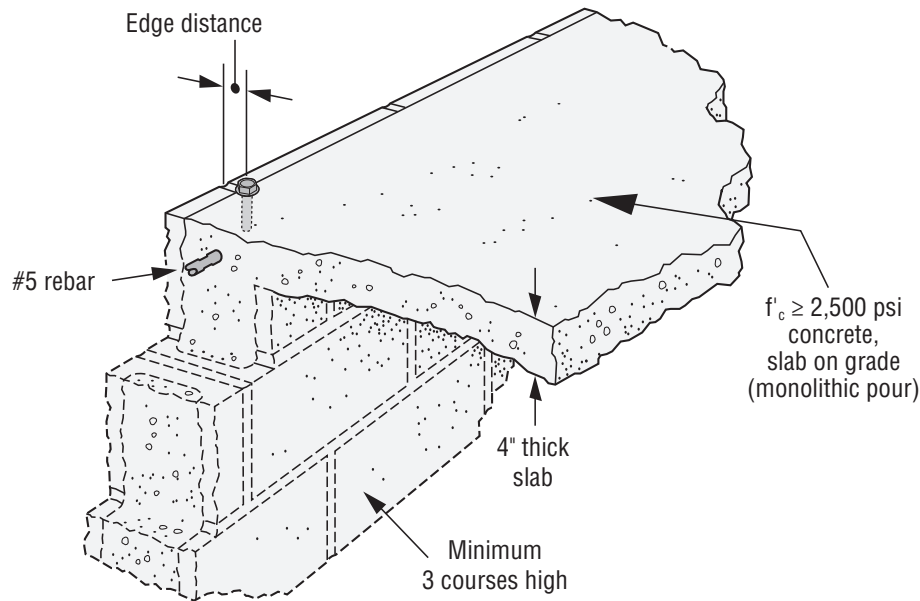

C-A-2021 © 2021 SIMPSON STRONG-TIE COMPANY INC.

\* See p. 12 for an explanation of the load table icons.

# Titen HD® Design Information — Masonry

## Load-Adjustment Factors for Titen HD Anchors in Face-of-Wall Installation in 8" Grout-Filled CMU: Edge Distance and Spacing, Tension and Shear Loads

### How to use these charts:

- The following tables are for reduced edge distance and spacing.
- Locate the anchor size to be used for either a tension and/or shear load application.
- Locate the embedment (E) at which the anchor is to be installed.
- Locate the edge distance ( $c_{act}$ ) or spacing ( $s_{act}$ ) at which the anchor is to be installed.
- The load adjustment factor ( $f_c$  or  $f_s$ ) is the intersection of the row and column.
- Multiply the allowable load by the applicable load adjustment factor.
- Reduction factors for multiple edges or spacings are multiplied together.

### Edge Distance Tension ( $f_c$ )

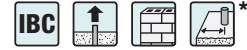

$c_{act}$ (in.)	Dia.	1/4	3/8	1/2	5/8	3/4
	E	2 1/2	2 3/4	3 1/2	4 1/2	5 1/2
	$c_{cr}$	4	12	12	12	12
	$c_{min}$	1.25	4	4	4	4
	$f_{cmin}$	0.77	1.00	1.00	0.83	0.66
1.25		0.77				
2		0.83				
3		0.92				
4		1.00	1.00	1.00	0.83	0.66
6		1.00	1.00	1.00	0.87	0.75
8		1.00	1.00	1.00	0.92	0.83
10		1.00	1.00	1.00	0.96	0.92
12		1.00	1.00	1.00	1.00	1.00

See footnotes below.

### Edge Distance Shear ( $f_c$ ) Shear Load Parallel to Edge or End



$c_{act}$ (in.)	Dia.	1/4	3/8	1/2	5/8	3/4
	E	2 1/2	2 3/4	3 1/2	4 1/2	5 1/2
	$c_{cr}$	4	12	12	12	12
	$c_{min}$	1.25	4	4	4	4
	$f_{cmin}$	0.58	0.77	0.48	0.46	0.44
1.25		0.58				
2		0.69				
3		0.85				
4		1.00	0.77	0.48	0.46	0.44
6		1.00	0.83	0.61	0.60	0.58
8		1.00	0.89	0.74	0.73	0.72
10		1.00	0.94	0.87	0.87	0.86
12		1.00	1.00	1.00	1.00	1.00

See footnotes below.

### Edge Distance Shear ( $f_c$ ) Shear Load Perpendicular to Edge or End (Directed Towards Edge or End)



$c_{act}$ (in.)	Dia.	1/4	3/8	1/2	5/8	3/4
	E	2 1/2	2 3/4	3 1/2	4 1/2	5 1/2
	$c_{cr}$	4	12	12	12	12
	$c_{min}$	1.25	4	4	4	4
	$f_{cmin}$	0.71	0.58	0.38	0.30	0.21
1.25		0.71				
2		0.79				
3		0.89				
4		1.00	0.58	0.38	0.30	0.21
6		1.00	0.69	0.54	0.48	0.41
8		1.00	0.79	0.69	0.65	0.61
10		1.00	0.90	0.85	0.83	0.80
12		1.00	1.00	1.00	1.00	1.00

- E = embedment depth (inches).
- $c_{act}$  = actual end or edge distance at which anchor is installed (inches).
- $c_{cr}$  = critical end or edge distance for 100% load (inches).
- $c_{min}$  = minimum end or edge distance for reduced load (inches).
- $f_c$  = adjustment factor for allowable load at actual end or edge distance.
- $f_{ccr}$  = adjustment factor for allowable load at critical end or edge distance.  $f_{ccr}$  is always = 1.00.
- $f_{cmin}$  = adjustment factor for allowable load at minimum end or edge distance.
- $f_c = f_{cmin} + [(1 - f_{cmin}) (C_{act} - C_{min}) / (C_{cr} - C_{min})]$ .

\* See p. 12 for an explanation of the load table icons.

# Titen HD® Design Information — Masonry

## Load-Adjustment Factors for Titen HD Anchors in Face-of-Wall Installation in 8" Grout-Filled CMU: Edge Distance and Spacing, Tension and Shear Loads (cont.)

### How to use these charts:

1. The following tables are for reduced edge distance and spacing.
2. Locate the anchor size to be used for either a tension and/or shear load application.
3. Locate the embedment (E) at which the anchor is to be installed.
4. Locate the edge distance ( $c_{act}$ ) or spacing ( $s_{act}$ ) at which the anchor is to be installed.
5. The load adjustment factor ( $f_c$  or  $f_s$ ) is the intersection of the row and column.
6. Multiply the allowable load by the applicable load adjustment factor.
7. Reduction factors for multiple edges or spacings are multiplied together.

### Edge Distance Shear ( $f_c$ ) Shear Load Perpendicular to Edge or End (Directed Away From Edge or End)



$c_{act}$ (in.)	Dia.	1/4	3/8	1/2	5/8	3/4
	E	2 1/2	2 3/4	3 1/2	4 1/2	5 1/2
	$c_{cr}$	4	12	12	12	12
	$c_{min}$	1.25	4	4	4	4
	$f_{cmin}$	0.71	0.89	0.79	0.58	0.38
1.25		0.71				
2		0.79				
3		0.89				
4		1.00	0.89	0.79	0.58	0.38
6		1.00	0.92	0.84	0.69	0.54
8		1.00	0.95	0.90	0.79	0.69
10		1.00	0.97	0.95	0.90	0.85
12		1.00	1.00	1.00	1.00	1.00

### Spacing Tension ( $f_s$ )



$s_{act}$ (in.)	Dia.	1/4	3/8	1/2	5/8	3/4
	E	2 1/2	2 3/4	3 1/2	4 1/2	5 1/2
	$s_{cr}$	4	6	8	10	12
	$s_{min}$	2	3	4	5	6
	$f_{smin}$	0.66	0.87	0.69	0.59	0.50
2		0.66				
3		0.83	0.87			
4		1.00	0.91	0.69		
5			0.96	0.77	0.59	
6			1.00	0.85	0.67	0.50
8				1.00	0.84	0.67
10					1.00	0.83
12						1.00

### Spacing Shear ( $f_s$ )



$s_{act}$ (in.)	Dia.	1/4	3/8	1/2	5/8	3/4
	E	2 1/2	2 3/4	3 1/2	4 1/2	5 1/2
	$s_{cr}$	4	6	8	10	12
	$s_{min}$	2	3	4	5	6
	$f_{smin}$	0.87	0.62	0.62	0.62	0.62
2		0.87				
3		0.93	0.62			
4		1.00	0.75	0.62		
5			0.87	0.72	0.62	
6			1.00	0.81	0.70	0.62
8				1.00	0.85	0.75
10					1.00	0.87
12						1.00

1. E = embedment depth (inches).
2.  $s_{act}$  = actual spacing distance at which anchors are installed (inches).
3.  $s_{cr}$  = critical spacing distance for 100% load (inches).
4.  $s_{min}$  = minimum spacing distance for reduced load (inches).
5.  $f_s$  = adjustment factor for allowable load at actual spacing distance.
6.  $f_{s_{cr}}$  = adjustment factor for allowable load at critical spacing distance.  $f_{s_{cr}}$  is always = 1.00.
7.  $f_{s_{min}}$  = adjustment factor for allowable load at minimum spacing distance.
8.  $f_s = f_{s_{min}} + [(1 - f_{s_{min}}) (s_{act} - s_{min}) / (s_{cr} - s_{min})]$ .

\* See p. 12 for an explanation of the load table icons.