

# LUC/LU/U/HU/HUC

## Standard Face-Mount Joist Hangers

LUC — Concealed-flange hanger available for 2x6, 2x8, 2x10 and 2x12 lumber. Ideal for end of ledger/header or post conditions, the LUCZ also provides cleaner lines for exposed conditions such as overhead decks.

LU — Value engineered for strength and economy. Precision-formed — engineered for installation ease and design value.

U — The standard U hanger provides flexibility of joist to header installation. Versatile fastener selection with tested allowable loads.

HU/HUC — Most models have triangle and round holes. To achieve maximum loads, fill both round and triangle holes with common nails. These heavy-duty connectors are designed for additional strength, longevity and safety factors.

**Material:** See tables on pp. 104–114

**Finish:** Galvanized. Some products available in ZMAX® coating or stainless steel.

### Installation:

- Use all specified fasteners; see General Notes.
- HU/HUC — Can be installed filling round holes only, or filling round and triangle holes for maximum values.
- Joists sloped up to ¼:12 achieve table loads.
- For installations to masonry or concrete see pp. 243–245.
- HU/HUC hangers can be welded to a steel member. Allowable loads are the lesser of the values in the hanger tables on pp. 104–114 or the weld capacity — refer to technical bulletin T-C-HUHUC-W at [strongtie.com](http://strongtie.com).
- When nailing into solid sawn carrying member's end grain, the allowable load is adjusted by a factor of 0.67.

### Allowable Loads:

- See table on pp. 104–114 for loads.

### Options:

- For both flanges concealed, order HUC.
- When the HUC is skewed, the header flange opposite the skew direction is not concealed. See p. 101.
- For low-cost, code approved 45° skewed hangers, see SUR/SUL.
- For field-adjustable hangers, see LSSJ, LRUZ and LSSR on pp. 117–119.
- See modifications table for available options and associated load capacities for U and HU hangers.
- For ease of ordering, refer to technical bulletin T-C-U-HU-WS at [strongtie.com](http://strongtie.com).
- LU/LUC cannot be modified.

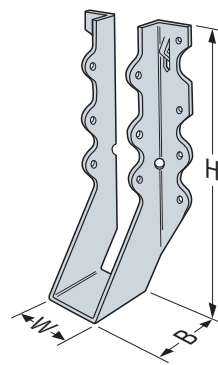

**LU28**  
(except LU roughs)

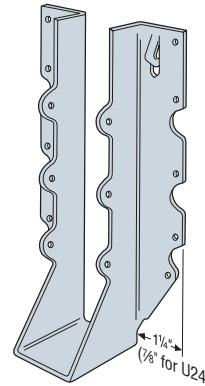

**U210**

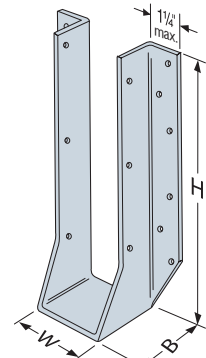

**HU214**

Projection seat on most models for maximum bearing and section economy.

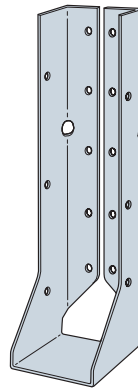

**LUC210Z**  
(LUC26Z similar)

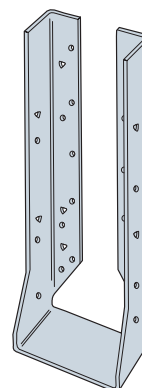

**HUC412**  
Concealed flanges

Model configurations may differ from those shown. Some HU models do not have triangle holes. Contact Simpson Strong-Tie.

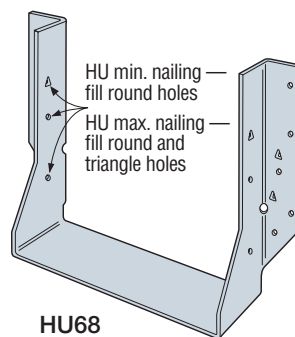

**HU68**

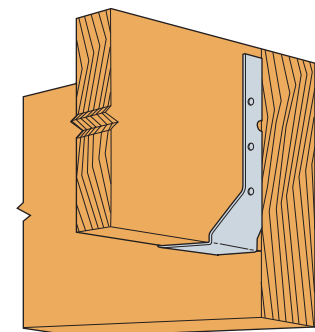

Typical LUCZ Installation

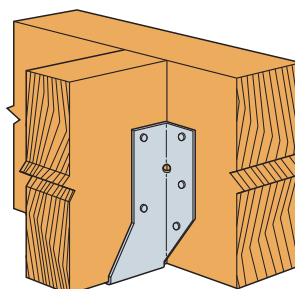

Typical HU Installation

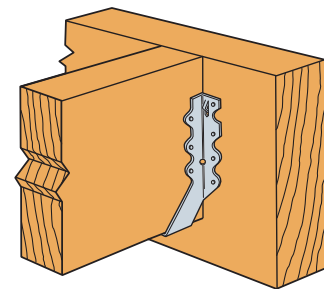

Typical LU28 Installation

# LUC/LU/U/HU/HUC

## Standard Face-Mount Joist Hangers (cont.)

### U/HU/HUC Series Modifications and Associated Load Reduction Factors

Seat			Flange	Fastener Substitutions		
Seat Sloped Up or Down 45° Max.	Seat Skewed 67½° Max. <sup>3</sup> for W ≤ 6 45° Max. for W > 6	Seat Sloped and Skewed	One or Both HU Flanges Concealed <sup>2</sup>	For Stainless-Steel Hangers Stainless-Steel Nails 0.162" x 3½"		Other Smooth-Shank Fastener Substitutions
1.00	W ≤ 3⅞ use 1.00 W > 3⅞ use 0.80	0.80	1.00 (normal) 0.80 (when sloped and skewed)	Ring shank (all conditions)	1.00	0.162" x 3½" → 0.162" x 2½" 1.00
				Smooth shank (normal seat)	1.00	0.162" x 3½" → 0.148" x 3" 0.84
				Smooth shank (modified seat) <sup>1</sup>	0.50	0.162" x 3½" → 0.148" x 1½" 0.64

1. Modified seat is sloped, skewed, or both. For stainless-steel hangers, if sloped only or skewed only, use a smooth-shank stainless-steel reduction of 0.65.
2. For hanger applications with both flanges concealed, W must be at least 2⅞". To order, ask for HUCXXX.  
For skewed HUC, only flange on acute side is concealed.
3. Skews over 50° require a square-cut joist.

### Reduction Factor Instructions

**Allowable Download** = Seat x Flange x Stainless Steel Nails x Other Fastener Substitutions x Table Load

**Allowable Uplift** = 0.75 x Face Fastener Type x Table Load for skewed or sloped  
1.00 x Face Fastener Type x Table Load for non-skewed or non-sloped

### Maximum Skew Angle for Skewed HUC Hangers

Hanger Width (in.)	Maximum Skew (degree)
2⅞	31
2⅞	31
2⅞	34
2¾	37
3⅞	41
3¾	42
> 3¾	45

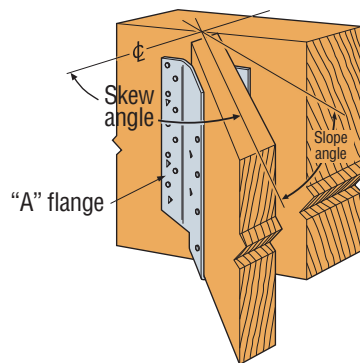

Typical HU Sloped Down, Skewed Right Installation

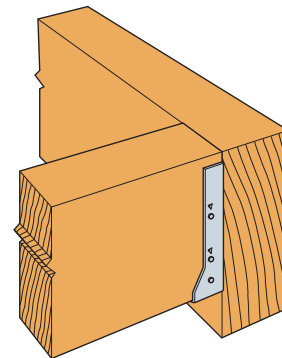

Typical HUC Installed on a Beam

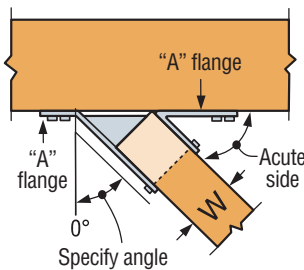

Top View U Hanger Skewed Right < 51° (square cut)

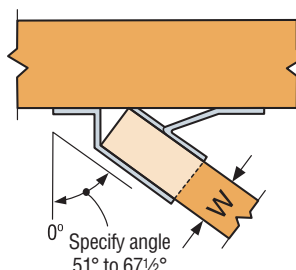

Top View U Hanger Skewed Right ≥ 51° (square cut)

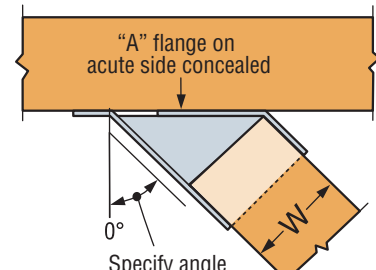

Top View HUC Concealed Hanger Skewed Right (square cut)

# Face-Mount Hangers — Rough Lumber (DF/SP)

**SD** Many of these products are approved for installation with Strong-Drive® SD Connector screws. See pp. 348–352 for more information.

**Codes:** See p. 11 for Code Reference Key Chart

Solid Sawn Joist Hangers

Joist Size	Model No.	Ga.	Dimensions (in.)			Fasteners (in.)		DF/SP Allowable Loads (lb.)				Code Ref.
			W	H	B	Header	Joist	Uplift (160)	Floor (100)	Snow (115)	Roof (125)	
<b>Sawn Lumber Sizes</b>												
2x4(R)	LU24R-18	18	2	3 <sup>1</sup> / <sub>16</sub>	1 <sup>1</sup> / <sub>2</sub>	(4) 0.162 x 3 <sup>1</sup> / <sub>2</sub>	(2) 0.148 x 1 <sup>1</sup> / <sub>2</sub>	240	555	630	655	—
	U24R	16	2	3 <sup>3</sup> / <sub>8</sub>	2	(4) 0.162 x 3 <sup>1</sup> / <sub>2</sub>	(2) 0.148 x 1 <sup>1</sup> / <sub>2</sub>	240	575	650	705	IBC, FL, LA
2x6(R)	LU26R-18	18	2	4 <sup>9</sup> / <sub>16</sub>	1 <sup>1</sup> / <sub>2</sub>	(6) 0.162 x 3 <sup>1</sup> / <sub>2</sub>	(4) 0.148 x 1 <sup>1</sup> / <sub>2</sub>	540	835	950	1,030	—
	U26R	16	2	5 <sup>5</sup> / <sub>8</sub>	2	(8) 0.162 x 3 <sup>1</sup> / <sub>2</sub>	(4) 0.148 x 1 <sup>1</sup> / <sub>2</sub>	535	1,150	1,305	1,410	IBC, FL, LA
2x8(R)	LU28R-18	18	2	6 <sup>5</sup> / <sub>8</sub>	1 <sup>1</sup> / <sub>2</sub>	(8) 0.162 x 3 <sup>1</sup> / <sub>2</sub>	(6) 0.148 x 1 <sup>1</sup> / <sub>2</sub>	850	1,110	1,180	1,180	—
	U26R	16	2	5 <sup>5</sup> / <sub>8</sub>	2	(8) 0.162 x 3 <sup>1</sup> / <sub>2</sub>	(4) 0.148 x 1 <sup>1</sup> / <sub>2</sub>	535	1,150	1,305	1,410	IBC, FL, LA
2x10(R)	LU210R-18	18	2	7 <sup>9</sup> / <sub>16</sub>	2	(10) 0.162 x 3 <sup>1</sup> / <sub>2</sub>	(6) 0.148 x 1 <sup>1</sup> / <sub>2</sub>	850	1,390	1,580	1,615	—
	U210R	16	2	9 <sup>1</sup> / <sub>8</sub>	2	(14) 0.162 x 3 <sup>1</sup> / <sub>2</sub>	(6) 0.148 x 1 <sup>1</sup> / <sub>2</sub>	990	2,015	2,280	2,465	IBC, FL, LA
2x12(R)	U210R	16	2	9 <sup>1</sup> / <sub>8</sub>	2	(14) 0.162 x 3 <sup>1</sup> / <sub>2</sub>	(6) 0.148 x 1 <sup>1</sup> / <sub>2</sub>	990	2,015	2,280	2,465	
2x14(R)	U210R	16	2	9 <sup>1</sup> / <sub>8</sub>	2	(14) 0.162 x 3 <sup>1</sup> / <sub>2</sub>	(6) 0.148 x 1 <sup>1</sup> / <sub>2</sub>	990	2,015	2,280	2,465	
4x4(R)	U44R	16	4	2 <sup>5</sup> / <sub>8</sub>	2	(4) 0.162 x 3 <sup>1</sup> / <sub>2</sub>	(2) 0.162 x 3 <sup>1</sup> / <sub>2</sub>	240	575	650	705	
4x6(R)	U46R	16	4	4 <sup>5</sup> / <sub>8</sub>	2	(8) 0.162 x 3 <sup>1</sup> / <sub>2</sub>	(4) 0.162 x 3 <sup>1</sup> / <sub>2</sub>	535	1,150	1,305	1,410	
4x8(R)	U46R	16	4	4 <sup>5</sup> / <sub>8</sub>	2	(8) 0.162 x 3 <sup>1</sup> / <sub>2</sub>	(4) 0.162 x 3 <sup>1</sup> / <sub>2</sub>	535	1,150	1,305	1,410	
4x10(R)	U410R	16	4	8 <sup>1</sup> / <sub>8</sub>	2	(14) 0.162 x 3 <sup>1</sup> / <sub>2</sub>	(6) 0.162 x 3 <sup>1</sup> / <sub>2</sub>	990	2,015	2,280	2,465	
4x12(R)	U410R	16	4	8 <sup>1</sup> / <sub>8</sub>	2	(14) 0.162 x 3 <sup>1</sup> / <sub>2</sub>	(6) 0.162 x 3 <sup>1</sup> / <sub>2</sub>	990	2,015	2,280	2,465	
4x14(R)	U410R	16	4	8 <sup>1</sup> / <sub>8</sub>	2	(14) 0.162 x 3 <sup>1</sup> / <sub>2</sub>	(6) 0.162 x 3 <sup>1</sup> / <sub>2</sub>	990	2,015	2,280	2,465	
6x6(R)	U66R	16	6	5	2	(8) 0.162 x 3 <sup>1</sup> / <sub>2</sub>	(4) 0.162 x 3 <sup>1</sup> / <sub>2</sub>	535	1,150	1,305	1,410	
6x8(R)	U66R	16	6	5	2	(8) 0.162 x 3 <sup>1</sup> / <sub>2</sub>	(4) 0.162 x 3 <sup>1</sup> / <sub>2</sub>	535	1,150	1,305	1,410	
6x10(R)	U610R	16	6	8 <sup>1</sup> / <sub>2</sub>	2	(14) 0.162 x 3 <sup>1</sup> / <sub>2</sub>	(6) 0.162 x 3 <sup>1</sup> / <sub>2</sub>	990	2,015	2,280	2,465	
6x12(R)	U610R	16	6	8 <sup>1</sup> / <sub>2</sub>	2	(14) 0.162 x 3 <sup>1</sup> / <sub>2</sub>	(6) 0.162 x 3 <sup>1</sup> / <sub>2</sub>	990	2,015	2,280	2,465	
6x14(R)	U610R	16	6	8 <sup>1</sup> / <sub>2</sub>	2	(14) 0.162 x 3 <sup>1</sup> / <sub>2</sub>	(6) 0.162 x 3 <sup>1</sup> / <sub>2</sub>	990	2,015	2,280	2,465	

1. Uplift loads have been increased for earthquake or wind loading with no further increase allowed. Reduce where other loads govern.

2. DF/SP loads can be used for SCL with an equivalent specific gravity of 0.50 or greater.

3. HU hangers can be ordered in rough sizes at full table loads. Add "X" to the model designation (e.g., HU28X) and specify rough width or height. Maximum width 8".

4. **Fasteners:** Nail dimensions are listed diameter by length. See pp. 21–22 for fastener information.

# Face-Mount Hangers — Rough Lumber (SPF/HF)

Joist Size	Model No.	Ga.	Dimensions (in.)			Fasteners (in.)		SPF/HF Allowable Loads (lb.)			
			W	H	B	Header	Joist	Uplift (160)	Floor (100)	Snow (115)	Roof (125)
<b>Sawn Lumber Sizes</b>											
2x4(R)	LU24R-18	18	2	3 <sup>1</sup> / <sub>16</sub>	1 <sup>1</sup> / <sub>2</sub>	(4) 0.162 x 3 <sup>1</sup> / <sub>2</sub>	(2) 0.148 x 1 <sup>1</sup> / <sub>2</sub>	205	475	540	565
	U24R	16	2	3 <sup>3</sup> / <sub>8</sub>	2	(4) 0.162 x 3 <sup>1</sup> / <sub>2</sub>	(2) 0.148 x 1 <sup>1</sup> / <sub>2</sub>	205	495	560	605
2x6(R)	LU26R-18	18	2	4 <sup>9</sup> / <sub>16</sub>	1 <sup>1</sup> / <sub>2</sub>	(6) 0.162 x 3 <sup>1</sup> / <sub>2</sub>	(4) 0.148 x 1 <sup>1</sup> / <sub>2</sub>	465	720	815	885
	U26R	16	2	5 <sup>5</sup> / <sub>8</sub>	2	(8) 0.162 x 3 <sup>1</sup> / <sub>2</sub>	(4) 0.148 x 1 <sup>1</sup> / <sub>2</sub>	460	990	1,120	1,215
2x8(R)	LU28R-18	18	2	6 <sup>5</sup> / <sub>8</sub>	1 <sup>1</sup> / <sub>2</sub>	(8) 0.162 x 3 <sup>1</sup> / <sub>2</sub>	(6) 0.148 x 1 <sup>1</sup> / <sub>2</sub>	730	955	1,015	1,015
	U26R	16	2	5 <sup>5</sup> / <sub>8</sub>	2	(8) 0.162 x 3 <sup>1</sup> / <sub>2</sub>	(4) 0.148 x 1 <sup>1</sup> / <sub>2</sub>	460	990	1,120	1,215
2x10(R)	LU210R-18	18	2	7 <sup>9</sup> / <sub>16</sub>	2	(10) 0.162 x 3 <sup>1</sup> / <sub>2</sub>	(6) 0.148 x 1 <sup>1</sup> / <sub>2</sub>	730	1,195	1,360	1,390
	U210R	16	2	9 <sup>1</sup> / <sub>8</sub>	2	(14) 0.162 x 3 <sup>1</sup> / <sub>2</sub>	(6) 0.148 x 1 <sup>1</sup> / <sub>2</sub>	850	1,735	1,960	2,120
2x12(R)	U210R	16	2	9 <sup>1</sup> / <sub>8</sub>	2	(14) 0.162 x 3 <sup>1</sup> / <sub>2</sub>	(6) 0.148 x 1 <sup>1</sup> / <sub>2</sub>	850	1,735	1,960	2,120
2x14(R)	U210R	16	2	9 <sup>1</sup> / <sub>8</sub>	2	(14) 0.162 x 3 <sup>1</sup> / <sub>2</sub>	(6) 0.148 x 1 <sup>1</sup> / <sub>2</sub>	850	1,735	1,960	2,120
4x4(R)	U44R	16	4	2 <sup>5</sup> / <sub>8</sub>	2	(4) 0.162 x 3 <sup>1</sup> / <sub>2</sub>	(2) 0.162 x 3 <sup>1</sup> / <sub>2</sub>	205	495	560	605
4x6(R)	U46R	16	4	4 <sup>5</sup> / <sub>8</sub>	2	(8) 0.162 x 3 <sup>1</sup> / <sub>2</sub>	(4) 0.162 x 3 <sup>1</sup> / <sub>2</sub>	460	990	1,120	1,215
4x8(R)	U46R	16	4	4 <sup>5</sup> / <sub>8</sub>	2	(8) 0.162 x 3 <sup>1</sup> / <sub>2</sub>	(4) 0.162 x 3 <sup>1</sup> / <sub>2</sub>	460	990	1,120	1,215
4x10(R)	U410R	16	4	8 <sup>1</sup> / <sub>8</sub>	2	(14) 0.162 x 3 <sup>1</sup> / <sub>2</sub>	(6) 0.162 x 3 <sup>1</sup> / <sub>2</sub>	850	1,735	1,960	2,120
4x12(R)	U410R	16	4	8 <sup>1</sup> / <sub>8</sub>	2	(14) 0.162 x 3 <sup>1</sup> / <sub>2</sub>	(6) 0.162 x 3 <sup>1</sup> / <sub>2</sub>	850	1,735	1,960	2,120
4x14(R)	U410R	16	4	8 <sup>1</sup> / <sub>8</sub>	2	(14) 0.162 x 3 <sup>1</sup> / <sub>2</sub>	(6) 0.162 x 3 <sup>1</sup> / <sub>2</sub>	850	1,735	1,960	2,120
6x6(R)	U66R	16	6	5	2	(8) 0.162 x 3 <sup>1</sup> / <sub>2</sub>	(4) 0.162 x 3 <sup>1</sup> / <sub>2</sub>	460	990	1,120	1,215
6x8(R)	U66R	16	6	5	2	(8) 0.162 x 3 <sup>1</sup> / <sub>2</sub>	(4) 0.162 x 3 <sup>1</sup> / <sub>2</sub>	460	990	1,120	1,215
6x10(R)	U610R	16	6	8 <sup>1</sup> / <sub>2</sub>	2	(14) 0.162 x 3 <sup>1</sup> / <sub>2</sub>	(6) 0.162 x 3 <sup>1</sup> / <sub>2</sub>	850	1,735	1,960	2,120
6x12(R)	U610R	16	6	8 <sup>1</sup> / <sub>2</sub>	2	(14) 0.162 x 3 <sup>1</sup> / <sub>2</sub>	(6) 0.162 x 3 <sup>1</sup> / <sub>2</sub>	850	1,735	1,960	2,120
6x14(R)	U610R	16	6	8 <sup>1</sup> / <sub>2</sub>	2	(14) 0.162 x 3 <sup>1</sup> / <sub>2</sub>	(6) 0.162 x 3 <sup>1</sup> / <sub>2</sub>	850	1,735	1,960	2,120

1. Uplift loads have been increased for earthquake or wind loading with no further increase allowed. Reduce where other loads govern.

2. DF/SP loads can be used for SCL with an equivalent specific gravity of 0.50 or greater.

3. HU hangers can be ordered in rough sizes at full table loads. Add "X" to the model designation (e.g., HU28X) and specify rough width or height. Maximum width 8".

4. **Fasteners:** Nail dimensions are listed diameter by length. See pp. 21–22 for fastener information.