

ICC-ES Evaluation Report

ESR-2555

Reissued November 2024

This report also contains:

- [City of LA Supplement](#)

Subject to renewal November 2025

- [FL Supplement w/HVHZ](#)

ICC-ES Evaluation Reports are not to be construed as representing aesthetics or any other attributes not specifically addressed, nor are they to be construed as an endorsement of the subject of the report or a recommendation for its use. There is no warranty by ICC Evaluation Service, LLC, express or implied, as to any finding or other matter in this report, or as to any product covered by the report.

Copyright © 2024 ICC Evaluation Service, LLC. All rights reserved.

| | | | |
|---|--|--|---|
| <p>DIVISION: 03 00 00— CONCRETE</p> <p>Section: 03 16 00— Concrete Anchors</p> <p>DIVISION: 06 00 00— WOOD, PLASTICS AND COMPOSITES</p> <p>Section: 06 05 23— Wood, Plastic, and Composite Fastenings</p> | <p>REPORT HOLDER: SIMPSON STRONG-TIE COMPANY INC.</p>  | <p>EVALUATION SUBJECT: SIMPSON STRONG-TIE® CAST-IN-PLACE FOUNDATION ANCHOR STRAPS</p> |  |
|---|--|--|---|

1.0 EVALUATION SCOPE

Compliance with the following codes:

- 2021, 2018, 2015 and 2012 [International Building Code® \(IBC\)](#)
- 2021, 2018, 2015 and 2012 [International Residential Code \(IRC\)](#)

Property evaluated:

Structural

2.0 USES

The Simpson Strong-Tie® MASA and MASAP foundation anchor straps described in this report are used to connect light-frame construction wood foundation plates (sill plates), having a 2-inch or 3-inch nominal thickness [1.5 or 2.5 inch (38 or 64 mm) actual thickness], or cold-formed steel (CFS) track, to concrete foundations or foundation walls.

The Simpson Strong-Tie MASOZ and MASOPZ foundation anchor straps described in this report are used to connect light-frame construction wood foundation plates (sill plates), having a 2-inch or 3-inch nominal thickness, covered with wood structural panel sheathing to concrete foundations or foundation walls.

The anchor straps are structural connectors cast-in-place into normalweight concrete, and resist uplift and sliding forces that result from the application of code-prescribed loads for light-frame construction in accordance with Sections [1604.8.1](#) and [2308.3.1](#) of the 2021, 2018, and 2015 IBC, and Section E2 of [AISI S230-19 for the 2021 IBC \(Section E2 of AISI S230-15 for the 2018 IBC\)](#) as referenced in the IBC, and Sections [1604.8.1](#), [2308.3.3](#), [2308.6](#), [2308.11.3.1](#), [2308.12.8](#), and [2308.12.9](#) of the 2012 IBC. These foundation anchor straps may also be used under the IRC in accordance with IRC Sections [R301.1.3](#), [R403.1.6](#), [R602.11.1](#) and [R603.3.1](#). For applications with CFS, the MASA and MASAP resist uplift and sliding forces in accordance with Section [2211.1.2](#) of the 2021 and 2018 IBC, Section [2211.7](#) of the 2015 and 2012 IBC and Section R603.3.1 of the IRC.

3.0 DESCRIPTION

3.1 Foundation Anchor Straps:

3.1.1 MASA and MASAP: The MASA and MASAP foundation anchor straps are manufactured from No. 16 gage [0.0555-inch base-metal thickness (1.4 mm)], cold-formed, galvanized sheet steel. Each anchor strap has one end that embeds into a concrete foundation. This end of the anchor strap has two standoff legs that facilitate placement onto the concrete formwork in accordance with the installation instructions prior to placement of concrete. The other end of the foundation anchor strap extends above the concrete foundation or foundation wall and is field-bent over nominally 2-inch or 3-inch wood foundation sill plates (sole plates) or over built-up CFS bottom tracks and is fastened to the foundation sill plate or bottom track, or fastened to both the foundation sill plate or bottom track and an adjacent stud, as shown in [Figure 3](#) and [Figure 6](#). The MASA anchor strap is die-formed into a shape that facilitates installation at the top of concrete forms as shown in [Figure 1](#), and the MASAP anchor strap is die-formed into a shape that facilitates installation for panelized formwork as shown in [Figure 2](#).

3.1.2 MASOZ and MASOPZ: The MASOZ and MASOPZ foundation anchor straps are manufactured from No. 16 gage [0.0555-inch base-metal thickness (1.4 mm)], cold-formed, galvanized sheet steel. Each anchor strap has two legs that embed into the concrete foundation. The other end of the foundation strap extends above the concrete foundation or foundation wall and is fastened to the foundation sill plate through plywood or OSB sheathing up to $\frac{1}{2}$ inch (12.7 mm) thick. Depending on the sheathing configuration and model selected the MASOZ/MASOPZ may need to be field-bent into its final position. The MASOZ anchor strap is die-formed into a shape that facilitates installation at the top of concrete forms as shown in [Figure 7](#). The MASOPZ anchor strap is die-formed into a shape that facilitates installation on panelized formwork as shown in [Figure 8](#). The sheathed wall panel can be installed flush with the face of the concrete as shown in [Figure 9](#) or overhanging as shown in [Figure 10](#).

3.2 Materials:

3.2.1 Connector Steel: The foundation anchor straps described in this report are manufactured from galvanized steel complying with [ASTM A653](#), SS designation, Grade 33, with a minimum yield strength, F_y , of 33,000 psi (227 MPa) and a minimum tensile strength, F_u , of 45,000 psi (310 MPa). MASA and MASAP anchor straps have a minimum G90 zinc coating specification in accordance with ASTM A653. These anchors are also available with a G185 zinc coating, denoted by model numbers ending with Z. Model numbers in this report do not list the Z ending, but the information shown applies. MASOZ and MASOPZ are only available with a G185 zinc coating. The lumber treater's recommendations or recommendations of Simpson Strong-Tie Company, Inc., on minimum corrosion resistance and connection capacities of connectors used with the specific proprietary preservative-treated or fire-retardant treated lumber, must be followed.

3.2.2 Cold-formed Steel (CFS) Structural Members: The allowable loads for connectors described in this evaluation report for anchorage of CFS tracks are based on CFS members (see applicable portions of [Table 1](#) and [Figure 6](#)) evaluated using No. 18 gage [43-mil (1.09 mm) base-metal thickness] steel complying with ASTM A653, Grade 33, $F_y = 33$ ksi, $F_u = 45$ ksi.

3.2.3 Wood: Wood members with which the connectors are used must be either sawn lumber or, when approved by the code official, engineered lumber complying with an ICC-ES evaluation report. The maximum moisture content is 19 percent for sawn lumber and 16 percent for engineered lumber except as noted in Section 4.1 of this report, and the minimum assigned specific gravity, SG_{NDS} , or equivalent specific gravity, SG_{eq} , as applicable, is 0.50. Wood foundation sill plates (sole plates) must comply with Sections [2304.3.1](#) and [2304.12.1.2](#) of the 2021, 2018, and 2015 IBC and Sections [2304.3.1](#) and [2304.11.2.2](#) of the 2012 IBC; or Sections [R404.3](#) and [R602.3.4](#) of the IRC. MASA/MASAP installations over sheathing shown in [Figure 5](#) are for maximum $\frac{1}{2}$ -inch nominal sheathing thickness. MASOZ/MASOPZ installations over sheathing shown in [Figures 9](#) through [11](#) are for minimum $\frac{3}{8}$ inch and maximum $\frac{1}{2}$ inch nominal sheathing thickness. The sheathing must be OSB, Structural 1 plywood, or plywood of species known to have SG_{NDS} equal to or greater than 0.50. The sheathing must comply with DOC PS1 or PS2, as applicable. The sheathing must also comply with Section 2304.12.1.2 of the 2021, 2018, and 2015 IBC or Section 2304.11.2.2 of the 2012 IBC.

3.2.4 Fasteners: Nails for foundation anchor straps in this report, for use in wood installations, must be bright or hot-dipped galvanized carbon steel nails complying with [ASTM F1667](#) with the minimum dimensions and bending yield strength (F_{yb}) shown in the following table. Alternatively, nails of other materials or finishes may be used when they are addressed in an ICC-ES evaluation report as having bending yield strength and withdrawal capacity equal to or better than those of a bright carbon steel nail of the same nominal diameter. Self-tapping screw fasteners, used in CFS installations, must comply with [ASTM C1513](#) and must extend through the CFS material a minimum of three exposed threads in accordance with American Iron and Steel Institute (AISI) S240. See [Table A](#) below for further fastener information:

TABLE A—FASTENER REQUIREMENTS

| NAIL TYPE | SHANK DIAMETER (in.) | LENGTH (in.) | F_y (psi) |
|------------------|--------------------------|--------------|-------------------------|
| 10d×1½ common | 0.148 | 1½ | 90,000 |
| 10d×2½ common | 0.148 | 2½ | 90,000 |
| #10 Screw | 0.190 (nominal diameter) | ¾ | See Section 3.2.4 above |

For **SI**: 1 in. = 25.4 mm, 1 psi = 6.89 kPa.

Nails used in contact with preservative-treated or fire-retardant-treated lumber must be hot-dipped galvanized carbon steel nails. Nails of other materials or finishes may be used when they are addressed in an ICC-ES evaluation report for use in the applicable treated lumber.

3.2.5 Concrete: Concrete must be normalweight concrete complying with the provisions of IBC Chapter 19 or IRC Section [R402.2](#), as applicable. Design values in this report are based on a minimum specified concrete compressive strength, f_c , of 2,500 psi (17.2 MPa) at 28 days.

4.0 DESIGN AND INSTALLATION

4.1 Design Strength:

The allowable loads shown in the product tables of this report are based on Allowable Stress Design (ASD) and include the load duration factor, C_D , corresponding with the applicable loads in accordance with the *National Design Specification® for Wood Construction* (NDS), where applicable. The allowable loads are shown for different conditions, including installation configuration (2x- and 3x- wood members, CFS track size, standard, one leg up, two legs up, etc.), load direction (Uplift, F1, F2), load type (seismic or wind) and whether the concrete is cracked or uncracked. The allowable load values based on uncracked concrete are for use where analysis indicates no concrete cracking ($f_t < f_r$) at service (unfactored) load levels. [Footnote 6](#) of [Table 1](#) and [Table 2](#) describes the required procedure for converting the tabulated allowable stress (ASD) loads to strength design (LRFD) load values.

Tabulated allowable loads apply to foundation anchor straps connected to wood used under dry conditions and where sustained temperatures are 100°F (37.8°C) or less. When foundation anchor straps are nailed to wood that will experience sustained exposure to temperatures exceeding 100°F (37.8°C), the allowable loads based on wood connection strength shown in [Table 1](#) or [Table 2](#), as applicable, must be adjusted by the temperature factor, C_t , specified in the NDS. When foundation anchor straps are nailed to sawn lumber having a moisture content greater than 19 percent (16 percent for engineered wood products), or where wet service is expected, the allowable loads must be adjusted by the wet service factor, C_M , specified in the NDS.

IBC Section [1613.1](#) contains an exception that permits detached one- and two-family dwellings assigned to Seismic Design Category (SDC) A, B, or C to be exempt from the seismic design provisions of IBC Section [1613](#). When this is the case, as determined by the code official, the allowable wind (or SDC A and B) loads assigned to the anchor straps in [Table 1](#) or [Table 2](#), as applicable, may be used.

4.2 Installation:

The foundation anchor straps must be installed in accordance with this evaluation report and the manufacturer's published installation instructions. In the event of a conflict between this report and the manufacturer's published installation instructions, the most restrictive requirements govern. For buildings regulated under the IRC and for buildings of conventional light-frame construction regulated under IBC Section [2308](#), the foundation anchor straps described in this report may be used to attach foundation plates (sole/sill plates) to concrete foundations or foundation walls, provided a satisfactory design is submitted to the code official showing that the specified spacing of the anchor straps provides equivalent anchorage to what is prescribed in the code.

Connectors used with wood may be installed over sheathing as indicated in Tables 1 and 2. Connectors used with CFS members must not be installed over sheathing.

4.3 Special Inspection:

4.3.1 For the purpose of determining special inspection requirements, connectors may be considered to be special cases in accordance with Section [1705.1.1](#) of the IBC. Periodic special inspection shall be provided except where otherwise required or excepted by specific provisions of the IBC.

4.3.2 For installations under the IRC, special inspections are not required.

5.0 CONDITIONS OF USE:

The Simpson Strong-Tie foundation anchor straps described in this report comply with, or are suitable alternatives to what is specified in, those codes listed in [Section 1.0](#) of this report, subject to the following conditions:

- 5.1 The connectors must be manufactured, identified and installed in accordance with this report and the manufacturer's published installation instructions. A copy of the instructions must be available at the jobsite at all times during installation. In the event of a conflict between this report and the manufacturer's published installation instructions, the more restrictive requirements shall govern.
- 5.2 Calculations and details showing compliance with this report must be submitted to the code official. The calculations must be prepared by a registered design professional where required by the statutes of the jurisdiction in which the project is to be constructed.
- 5.3 Adjustment factors noted in [Section 4.1](#) and the applicable codes must be considered, where applicable.
- 5.4 The supporting concrete member must be designed by others to resist the applied uplift and shear forces transferred by the connectors.
- 5.5 Connected wood members and fasteners must comply with [Sections 3.2.3](#) and [3.2.4](#), respectively. Connected cold-formed steel members and fasteners must comply with [Sections 3.2.2](#) and [3.2.4](#), respectively.
- 5.6 Use of connectors with preservative- or fire-retardant-treated lumber shall be in accordance with [Section 3.2.1](#). Use of fasteners with preservative- or fire-retardant-treated lumber shall be in accordance with [Section 3.2.4](#) of this report.
- 5.7 Special inspection must be provided in accordance with [Section 4.3](#) of this report.
- 5.8 The connectors are manufactured under a quality control program with inspections by ICC-ES.

6.0 EVIDENCE SUBMITTED

Data in accordance with the [ICC-ES Acceptance Criteria for Steel Connectors for Connecting Light-Frame Construction Members to Concrete \(AC398\)](#), dated February 2020 (editorially revised December 2020).

7.0 IDENTIFICATION

- 7.1 The Simpson Strong-Tie foundation anchor straps described in this report are identified with a die-stamped label or an adhesive label indicating the name of the manufacturer (Simpson Strong-Tie), the model number, and the number of an index evaluation report ([ESR-2523](#)) that is used as an identifier for the products addressed in this report.
- 7.2 The report holder's contact information is the following:

SIMPSON STRONG-TIE COMPANY INC.
5956 WEST LAS POSITAS BOULEVARD
PLEASANTON, CALIFORNIA 94588
(800) 999-5099
www.strongtie.com

TABLE 1—ALLOWABLE STRESS DESIGN (ASD) LOADS FOR MASA AND MASAP FOUNDATION ANCHOR STRAPS

| Wind and SDC A&B - Allowable Loads (lbf) ^{1,4,5,6,8,9,10} | | | | | | | | |
|--|------------------------|---------------|-----------------------------------|------|------|---------------------------------|------|-----|
| Sill Plate/Track Size ¹² | Fasteners ² | | Uncracked Concrete ^{3,7} | | | Cracked Concrete ^{3,7} | | |
| | Sides | Top | Uplift | F1 | F2 | Uplift | F1 | F2 |
| STANDARD INSTALLATION | | | | | | | | |
| 2x4, 2x6 | 3-10dx1.5 | 6-10dx1.5 | 920 | 1475 | 1095 | 750 | 1475 | 875 |
| 3x4, 3x6 | 5-10dx1.5 | 4-10dx1.5 | 630 | 1165 | 725 | 475 | 1165 | 725 |
| ONE LEG UP INSTALLATION | | | | | | | | |
| 2x4, 2x6 | 6-10dx1.5 | 3-10dx1.5 | 755 | 965 | 995 | 570 | 965 | 930 |
| 3x4, 3x6 | 7-10dx1.5 | 2-10dx1.5 | - | 760 | - | - | 760 | - |
| TWO LEGS UP INSTALLATION | | | | | | | | |
| 2x4, 2x6 3x4, 3x6 | 9-10dx1.5 | - | 810 | 1105 | 865 | 620 | 1105 | 630 |
| DOUBLE 2x SILL INSTALLATION | | | | | | | | |
| DBL 2x4, DBL 2x6 | 5-10dx1.5 | 2-10dx1.5 | 840 | 1030 | 785 | 635 | 1030 | 785 |
| STANDARD INSTALLATION ON 2" CFS | | | | | | | | |
| 2" CFS Track ¹¹ | 3- #10 Screws | 9- #10 Screws | 645 | 1155 | 855 | 490 | 1155 | 630 |
| ONE LEG UP INSTALLATION ON 2" CFS | | | | | | | | |
| 2" CFS Track ¹¹ and Stud | 6- #10 Screws | 3- #10 Screws | - | 985 | - | - | 985 | - |
| SDC C-F - Allowable Loads (lbf) ^{1,4,5,6,8,9,10} | | | | | | | | |
| Sill Plate / Track Size ¹² | Fasteners ² | | Uncracked Concrete ^{3,7} | | | Cracked Concrete ^{3,7} | | |
| | Sides | Top | Uplift | F1 | F2 | Uplift | F1 | F2 |
| STANDARD INSTALLATION | | | | | | | | |
| 2x4, 2x6 | 3-10dx1.5 | 6-10dx1.5 | 745 | 1235 | 1045 | 660 | 1235 | 765 |
| 3x4, 3x6 | 5-10dx1.5 | 4-10dx1.5 | 550 | 1020 | 725 | 415 | 1020 | 640 |
| ONE LEG UP INSTALLATION | | | | | | | | |
| 2x4, 2x6 | 6-10dx1.5 | 3-10dx1.5 | 660 | 845 | 995 | 500 | 845 | 810 |
| 3x4, 3x6 | 7-10dx1.6 | 2-10dx1.6 | - | 665 | - | - | 665 | - |
| TWO LEGS UP INSTALLATION | | | | | | | | |
| 2x4, 2x6 3x4, 3x6 | 9-10dx1.5 | - | 740 | 965 | 755 | 560 | 965 | 555 |
| DOUBLE 2x SILL INSTALLATION | | | | | | | | |
| DBL 2x4, DBL 2x6 | 5-10dx1.5 | 2-10dx1.5 | 735 | 900 | 785 | 555 | 900 | 785 |
| STANDARD INSTALLATION ON 2" CFS | | | | | | | | |
| 2" CFS Track ¹¹ | 3- #10 Screws | 9- #10 Screws | 565 | 1010 | 750 | 425 | 1010 | 550 |
| ONE LEG UP INSTALLATION ON 2" CFS | | | | | | | | |
| 2" CFS Track ¹¹ and Stud | 6- #10 Screws | 3- #10 Screws | - | 860 | - | - | 860 | - |

For **SI**: 1 in. = 25.4 mm, 1 lbf = 4.45 N, 1 psi = 6.895 kPa.

¹Refer to [Figures 3 - 6](#) for illustrations of anchor straps fastened to wood plates or CFS tracks and wood plate/stud or CFS track/stud combinations. Allowable loads are applicable to anchors fastened directly to the sill plate, stud, or both, as applicable. For wood installations, the plate and stud members must have $SG_{NDS} \geq 0.50$ (SG_{NDS} = Assigned Specific Gravity determined in accordance with Table 12.3.3A of the [2018 NDS](#) for the 2021 and 2018 IBC, Table 12.3.3A of the [2015 NDS](#) for the 2015 IBC, and Table 11.3.3A of the [2012 NDS](#) for the 2012 IBC). CFS track and studs must comply with the minimum requirements of [Section 3.2.2](#), as applicable.

²Nails and screws must comply with [Section 3.2.4](#) of this report.

³Load direction F1 is parallel to the foundation plate wood member or the CFS track, and load direction F2 is perpendicular to the foundation plate wood member or CFS track. For simultaneous loads in more than one direction, the connector must be evaluated using the straight-line interaction equation.

⁴Minimum specified concrete compressive strength, f_c must be 2,500 psi.

⁵The minimum anchor end distance is 4 inches, the minimum anchor spacing is 8 inches, and the minimum concrete stem wall width is 6-inches.

⁶Multiply tabulated SDC D-F ASD load values and Wind and SDC A and B ASD load values by 1.43 and 1.67, respectively, to obtain LRFD capacities.

⁷The allowable load values based on uncracked concrete are for use where analysis indicates no concrete cracking at service (unfactored) load levels.

⁸IBC Section [1613.1](#) contains an exception that permits detached one- and two-family dwellings assigned to Seismic Design Category (SDC) A, B, or C to be exempt from the seismic design provisions of IBC Section [1613](#). When this is the case, the allowable Wind and SDC A and B loads assigned to the anchor straps should be used.

⁹The allowable loads for anchors fastened to wood members are based on allowable stress design (ASD) and include the load duration factor (C_D) corresponding with wind and earthquake loading in accordance with the NDS ($C_D = 1.6$). No further increase is allowed.

¹⁰Deflection at allowable load based on wood connection strength is less than or equal to $1/8$ inch.

¹¹CFS track or stud with flange width of 2 inches.

¹²Actual dimensions of wood members:

| Nominal Size | Actual Size | |
|--------------|-------------|------------|
| | Thickness | Face Width |
| 2x4 | 1.5 inches | 3.5 inches |
| 2x6 | 1.5 inches | 5.5 inches |
| 3x4 | 2.5 inches | 3.5 inches |
| 3x6 | 2.5 inches | 5.5 inches |

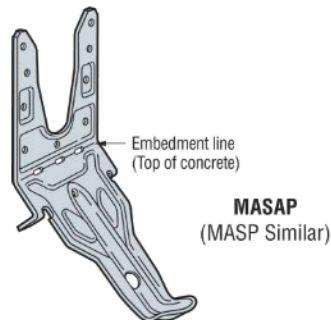
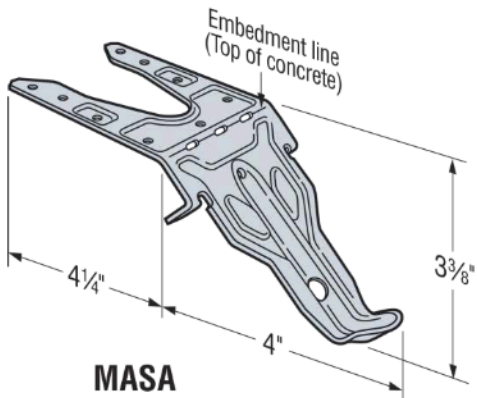
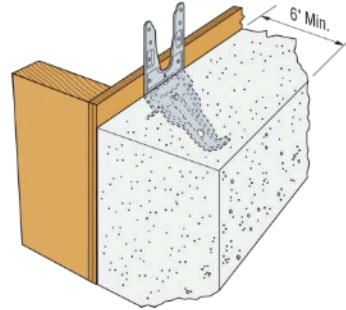
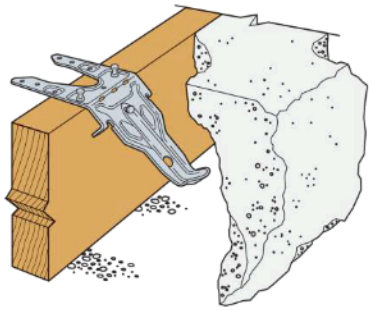

U.S. Patents 8,484,917 and D656,391S

FIGURE 1—MASA FOUNDATION ANCHOR STRAP

FIGURE 2—MASAP FOUNDATION ANCHOR STRAP

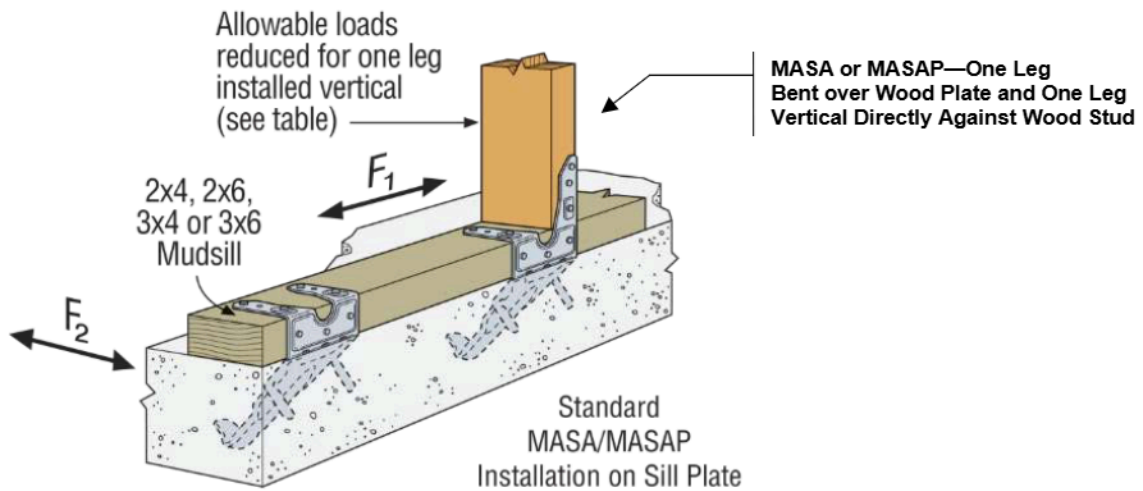

FIGURE 3—TYPICAL INSTALLATION OF MASA AND MASAP FOUNDATION ANCHOR STRAPS ON SILL PLATE

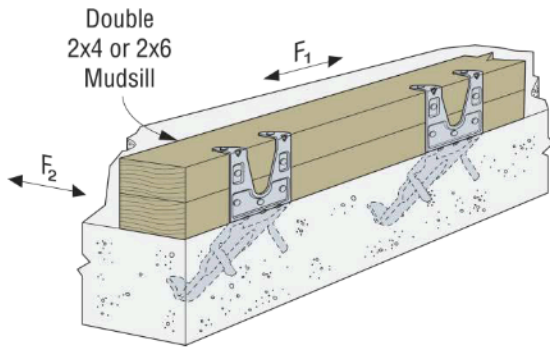

FIGURE 4—MASA/P INSTALLATION ON DOUBLE 2x MUDSILL

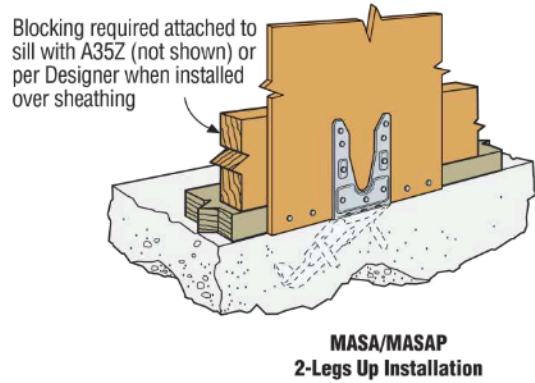

FIGURE 5—MASA/P INSTALLATION FOR TWO LEGS UP

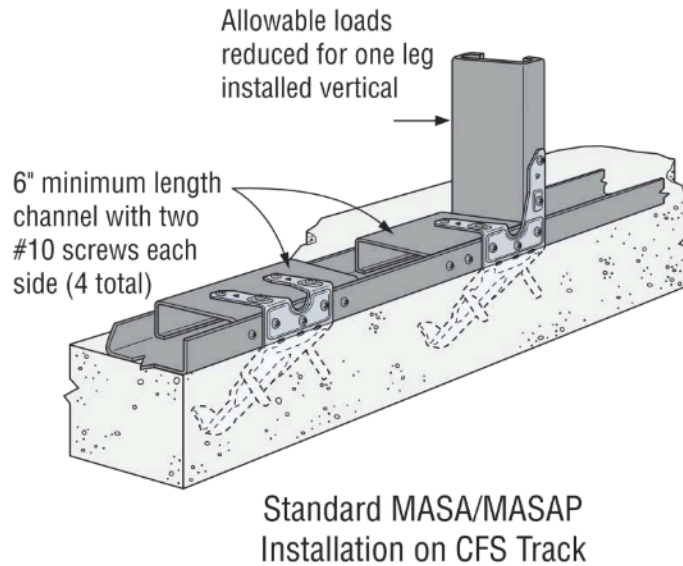

FIGURE 6—MASA/P INSTALLATION ON CFS TRACK

TABLE 2—ALLOWABLE STRESS DESIGN (ASD) LOADS FOR MASOZ AND MASOPZ FOUNDATION ANCHOR STRAPS

| Wind and SDC A&B - Allowable Loads (lbf) ^{1,4,5,6,8,9,10,11,12} | | | | | | | |
|--|------------------------|-----------------------------------|------|-----|---------------------------------|------|-----|
| Sill Plate Size ¹² | Fasteners ² | Uncracked Concrete ^{3,7} | | | Cracked Concrete ^{3,7} | | |
| | | Uplift | F1 | F2 | Uplift | F1 | F2 |
| 2x4, 2x6, 3x4, 3x6 | 7-10dx2.5 | 970 | 1295 | 465 | 675 | 1295 | 465 |
| SDC C-F - Allowable Loads (lbf) ^{1,4,5,6,8,9,10,11,12} | | | | | | | |
| Sill Plate Size ¹² | Fasteners ² | Uncracked Concrete ^{3,7} | | | Cracked Concrete ^{3,7} | | |
| | | Uplift | F1 | F2 | Uplift | F1 | F2 |
| 2x4, 2x6, 3x4, 3x6 | 7-10dx2.5 | 850 | 1295 | 465 | 595 | 1190 | 465 |

For SI: 1 in. = 25.4 mm, 1 lbf = 4.45 N, 1 psi = 6.895 kPa.

¹Refer to [Figures 9-11](#) for illustrations of anchor straps fastened through OSB or plywood sheathing into wood plates. The plate members must have $SG_{NDS} \geq 0.50$ (SG_{NDS} = Assigned Specific Gravity determined in accordance with Table 12.3.3A of the [2018 NDS](#) for the 2021 and 2018 IBC, Table 12.3.3A of the [2015 NDS](#) for the 2015 IBC, and Table 11.3.3A of the [2012 NDS](#) for the 2012 IBC).

²Nails must comply with Section 3.2.4 of this report.

³Load direction F1 is parallel to the foundation plate wood member, and load direction F2 is perpendicular to the foundation plate wood member. For simultaneous loads in more than one direction, the connector must be evaluated using the straight-line interaction equation.

⁴Minimum specified concrete compressive strength, f_c must be 2,500 psi.

⁵The minimum anchor end distance is 6 inches, the minimum anchor spacing is 12 inches, and the minimum concrete stem wall width is 6-inches.

⁶Multiply tabulated SDC D-F ASD load values and Wind and SDC A and B ASD load values by 1.43 and 1.67, respectively, to obtain LRFD capacities.

⁷The allowable load values based on uncracked concrete are for use where analysis indicates no concrete cracking at service (unfactored) load levels.

⁸IBC Section 1613 contains an exception that permits detached one- and two-family dwellings assigned to Seismic Design Category (SDC) A, B, or C to be exempt from the seismic design provisions of IBC Section 1613. When this is the case, the allowable Wind and SDC A and B loads assigned to the anchor straps should be used.

⁹The allowable loads for anchors fastened to wood members are based on allowable stress design (ASD) and include the load duration factor (C_D) corresponding with wind and earthquake loading in accordance with the NDS ($C_D = 1.6$). No further increase is allowed.

¹⁰Deflection at allowable load based on wood connection strength is less than or equal to $1/8$ inch.

¹¹The tabulated loads are based on sheathing which is OSB, Structural 1 plywood, or plywood of species known to have SG_{NDS} equal to or greater than 0.50.

¹²Actual dimensions of wood members:

| Nominal Size | Actual Size | |
|--------------|-------------|------------|
| | Thickness | Face Width |
| 2x4 | 1.5 inches | 3.5 inches |
| 2x6 | 1.5 inches | 5.5 inches |
| 3x4 | 2.5 inches | 3.5 inches |
| 3x6 | 2.5 inches | 5.5 inches |

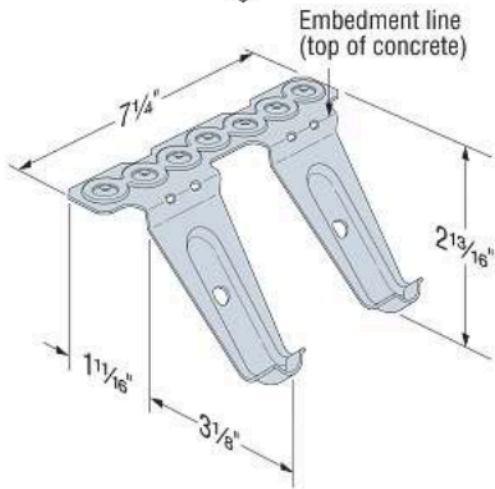
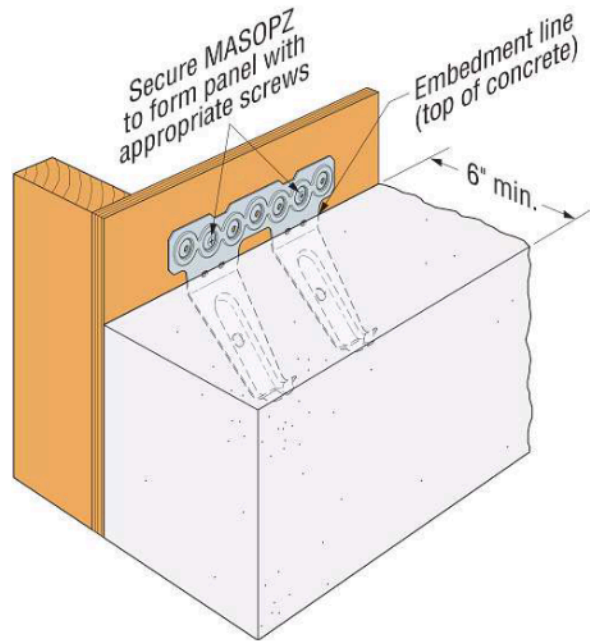
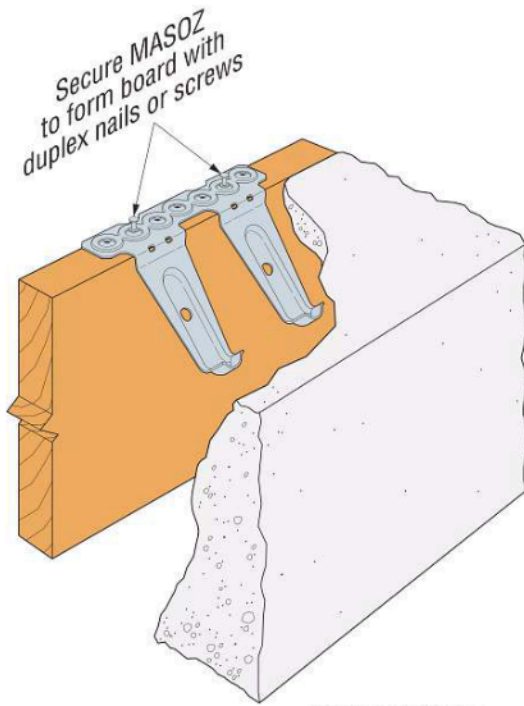

FIGURE 7—MASOZ FOUNDATION ANCHOR STRAP

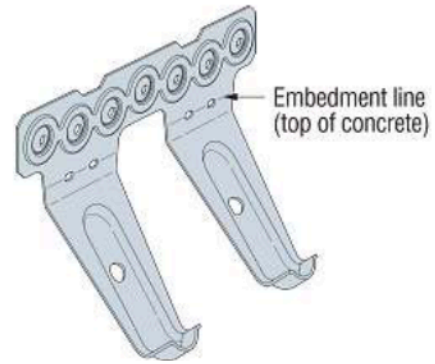

FIGURE 8—MASOPZ FOUNDATION ANCHOR STRAP

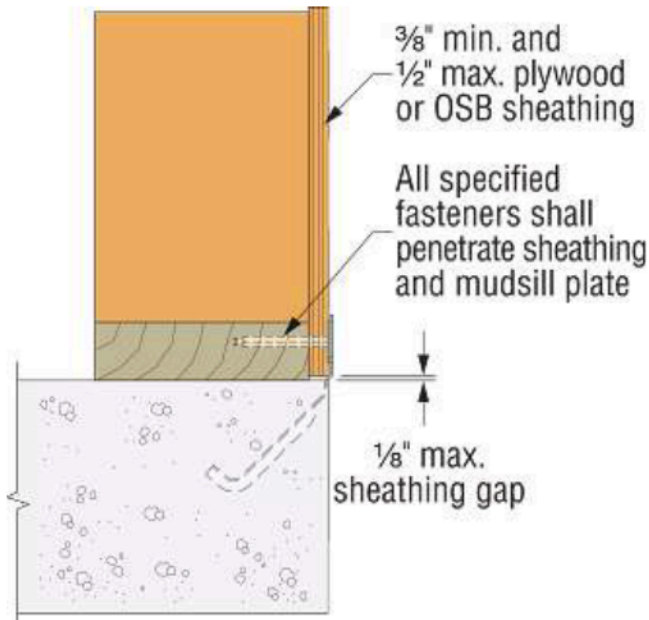

FIGURE 9 — MASOZ/MASOPZ FINAL INSTALLATION WITH SHEATHING FLUSH

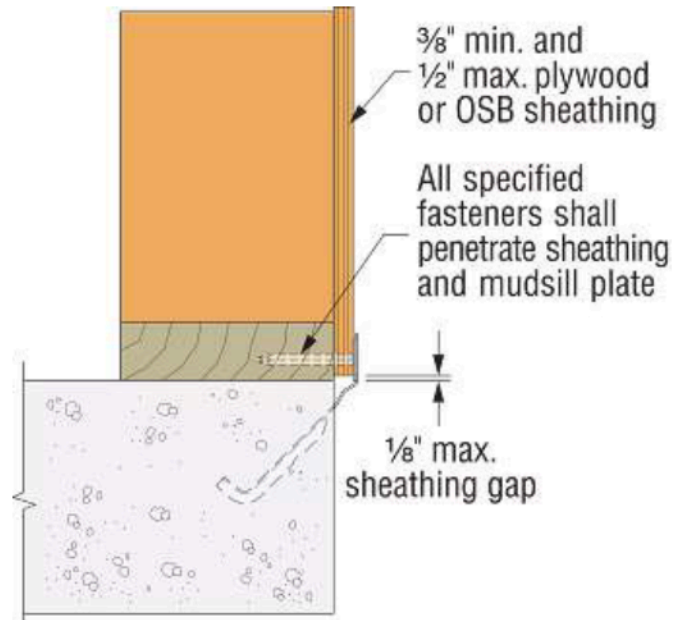

FIGURE 10 — MASOZ/MASOPZ FINAL INSTALLATION WITH OVERHANGING SHEATHING

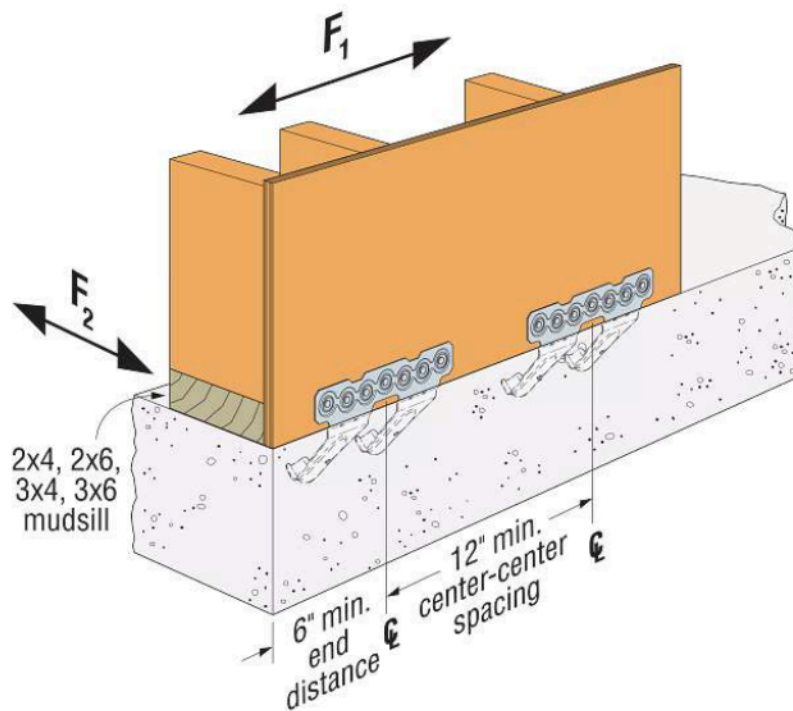

FIGURE 11 — TYPICAL MASOZ/MASOPZ INSTALLATION AND LOAD ORIENTATION

DIVISION: 03 00 00—CONCRETE

Section: 03 16 00—Concrete Anchors

DIVISION: 06 00 00—WOOD, PLASTICS AND COMPOSITES

Section: 06 05 23—Wood, Plastic, and Composite Fastenings

REPORT HOLDER:**SIMPSON STRONG-TIE COMPANY INC.****EVALUATION SUBJECT:****SIMPSON STRONG-TIE® CAST-IN-PLACE FOUNDATION ANCHOR STRAPS****1.0 REPORT PURPOSE AND SCOPE****Purpose:**

The purpose of this evaluation report supplement is to indicate that the Simpson Strong-Tie® Cast-In-Place Foundation Anchor Straps, described in ICC-ES evaluation report [ESR-2555](#), have also been evaluated for compliance with the codes noted below as adopted by the Los Angeles Department of Building and Safety (LADBS).

Applicable code editions:

- 2023 *City of Los Angeles Building Code* ([LABC](#))
- 2023 *City of Los Angeles Residential Code* ([LARC](#))

2.0 CONCLUSIONS

The Simpson Strong-Tie® Cast-In-Place Foundation Anchor Straps, described in Sections 2.0 through 7.0 of the evaluation report [ESR-2555](#), comply with LABC Chapters 19, 22 and 23, and the LARC, and are subjected to the conditions of use described in this supplement.

3.0 CONDITIONS OF USE

The Simpson Strong-Tie® Cast-In-Place Foundation Anchor Straps described in this evaluation report supplement must comply with all of the following conditions:

- All applicable sections in the evaluation report [ESR-2555](#).
- The design, installation, conditions of use and identification of the Simpson Strong-Tie® Cast-In-Place Foundation Anchor Straps are in accordance with the 2021 *International Building Code*® (IBC) provisions noted in the evaluation report [ESR-2555](#).
- The design, installation and inspection are in accordance with additional requirements of LABC Chapters 16 and 17, as applicable.
- Under the LARC, an engineered design in accordance with LARC Section R301.1.3 must be submitted.
- The seismic design provisions for hillside buildings referenced in LABC Section 2301.1 have not been considered and are outside the scope of this supplement.

This supplement expires concurrently with the evaluation report, reissued November 2024.

DIVISION: 03 00 00—CONCRETE
Section: 03 16 00—Concrete Anchors

DIVISION: 06 00 00—WOOD, PLASTICS AND COMPOSITES
Section: 06 05 23—Wood, Plastic, and Composite Fastenings

REPORT HOLDER:

SIMPSON STRONG-TIE COMPANY INC.

EVALUATION SUBJECT:

SIMPSON STRONG-TIE® CAST-IN-PLACE FOUNDATION ANCHOR STRAPS

1.0 REPORT PURPOSE AND SCOPE**Purpose:**

The purpose of this evaluation report supplement is to indicate that Simpson Strong-Tie® Cast-in-Place Foundation Anchor Straps, described in ICC-ES evaluation report ESR-2555, have also been evaluated for compliance with the codes noted below.

Applicable code editions:

- 2023 *Florida Building Code—Building*
- 2023 *Florida Building Code—Residential*

2.0 CONCLUSIONS

The Simpson Strong-Tie® Cast-in-Place Foundation Anchor Straps described in Sections 2.0 through 7.0 of ICC-ES evaluation report ESR-2555, comply with the *Florida Building Code—Building* and *Florida Building Code—Residential*. The design must be in accordance with the *Florida Building Code—Building* or the *Florida Building Code—Residential*, as applicable. The installation requirements noted in the ICC-ES evaluation report ESR-2555 for the 2021 *International Building Code*® meet the requirements of the *Florida Building Code—Building* or *Florida Building Code—Residential*, as applicable.

Use of the Simpson Strong-Tie® Cast-in-Place Foundation Anchor Straps has also been found to be in compliance with the High Velocity Hurricane Zone provisions of the *Florida Building Code—Building* and the *Florida Building Code—Residential* with the following condition:

- a. For connections subject to uplift, the connection must be designed for no less than 700 lbf (3,114 N).

For products falling under Florida Rule 61G20-3, verification that the report holder's quality assurance program is audited by a quality assurance entity approved by the Florida Building Commission for the type of inspections being conducted is the responsibility of an approved validation entity (or the code official when the report holder does not possess an approval by the Commission).

This supplement expires concurrently with the evaluation report, reissued November 2024.